

32" LCD IDTV

Digital & Analog TV with Built-in PVR

WIDESCREEN

LP32-TDR1

User's manual

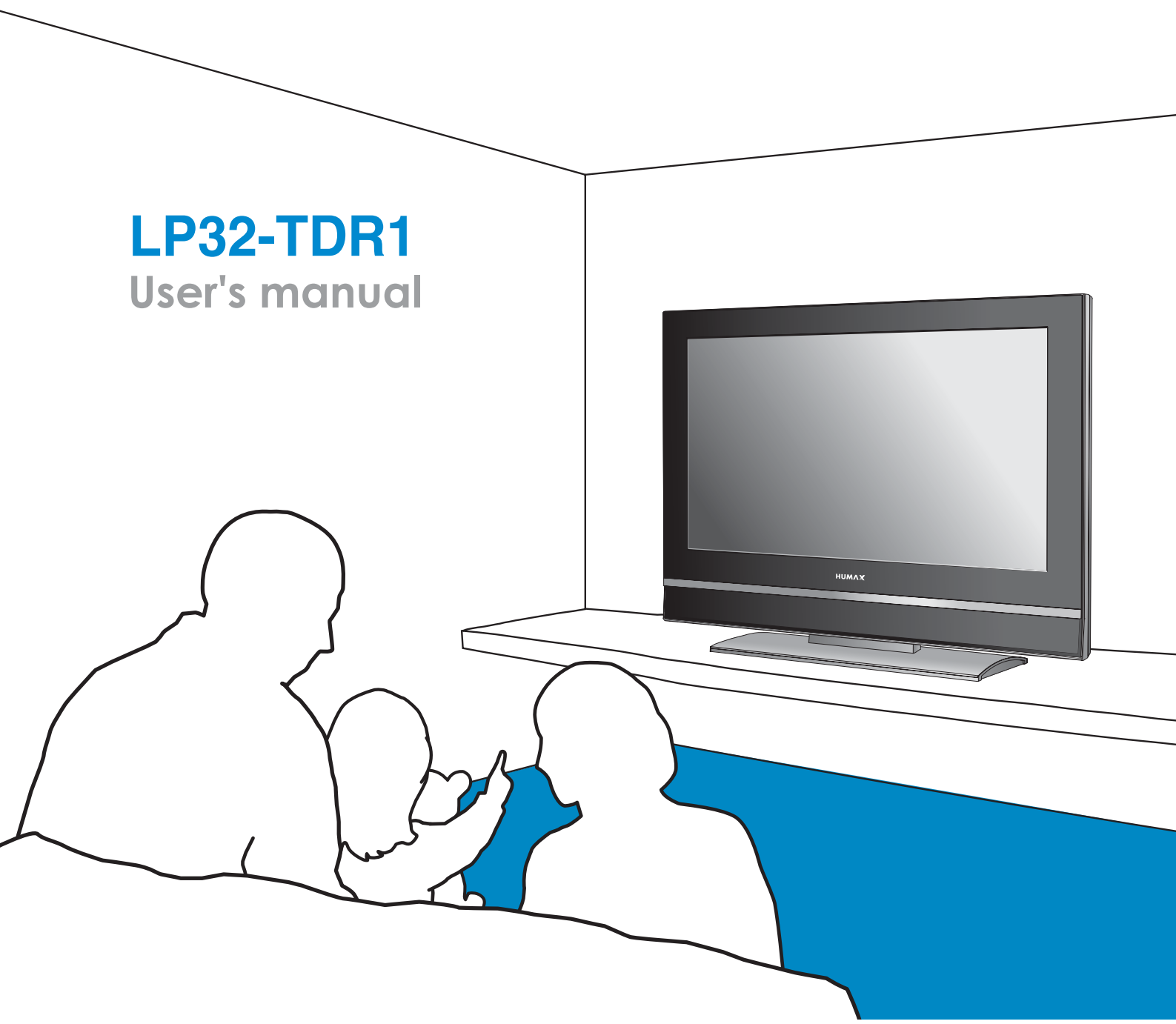



Notice

Read this manual carefully and make sure you understand the instructions provided. For your safety, check what the result of each action will be.



To reduce the risk of electric shock, do not remove cover (or back). No user serviceable parts inside. Refer servicing to qualified service personnel. Indicates a situation which, if not avoided, could damage the equipment or other apparatus.*



This symbol indicates dangerous voltage inside the TV that presents a risk of electric shock or personal injury. Indicates a hazardous situation which, if not avoided, could result in serious injury.



This symbol indicates important instructions accompanying the TV.



Disposal of electrical and electronic equipment

This equipment must not be disposed with the normal domestic refuse. Please direct your inquiry to disposal to your local disposal enterprises, environmental paper of your municipality or to your dealer, where you bought this product. You can help to reduce the consumption of raw materials by recycling the devices and protect the environment by professional disposal.

Copyright (Copyright © 2006 HUMAX Corporation)

Not to be copied, used or translated in part or whole without HUMAX's prior consent in writing except approval of ownership of copyright and copyright law.

Warranty

The information in this document is subject to change without notice. HUMAX does not have any responsibility for direct, indirect, accidental and other damage caused by the use of the information contained in this manual.

Trademarks

VIACCESS™ is a trademark of France Telecom.

CryptoWorks™ is a trademark of Philips Electronics N.V.

Irdeto is a trademark of Mindport BV.

Nagravision is a registered trademark of KUDELSKI S.A.

Conax is a trademark of Telenor Conax AS.

SRS(●) is a trademark of SRS Labs, Inc.

TruSurround XT technology is incorporated under license from SRS Labs, Inc.

Thank you for purchasing a HUMAX TV. Please read this user manual carefully in order to safely install, use and maintain the TV at maximum performance. Keep this user manual next to your TV to ensure the best performance possible.

General Safety Precautions

Power

- Plug the power cord into the correct power outlet. An unstable connection may cause fire.
- Do not use damaged power cords or plugs, or use a loose wall outlet. This may cause electrical shock or fire.
- Do never touch the power cord with wet hands. This may cause electrical shock.
- Do not use multiple devices with one outlet. Overheating the outlet may cause fire.
- Do not bend or pull out the power cord using force, nor place heavy objects over it. This may cause electrical shock or fire.
- Make sure you pull out the power cord holding the plug itself. An internal disconnection may cause fire.
- When removing the product, turn off the power and pull out the plug from the power outlet. Also make sure other devices including the antenna or the connectors are removed from the outlets before relocating the product. Otherwise you may suffer electrical shock or fire due to a damaged power cord.
- This TV shall be connected to mains socket outlet with a protective earthing connection.
- The mains plug shall remain readily operable.

Installation

- Keep the product away from any heating devices. Placing it close to a heating device may cause fire.
- Keep the power cord away from any heating devices. A melted coating may cause fire or electrical shock.
- Place the antenna as far away as possible from any high-voltage cables. Touching the high voltage wiring may cause fire or electrical shock.
- Do not install the product in oily, smoky or humid (or exposed to rain/water) places or automobiles. This may cause fire.
- The connection between the external antenna and the internal wiring should be turned inside to avoid any inflow of rain. Exposing the LCD to water (rain) will cause electrical shock or fire.
- Do not use the product in humid places. Humidity will shorten the life of the product and may cause an electrical shortage or fire.
- Do not use the product in places with low temperatures (below 5°C).
- Avoid installing the product in poorly ventilated places. Internal overheating may cause an electrical shortage and fire.
- Be sure not to cover the ventilator (with a table-cloth or curtain, etc.). Internal overheating may cause an electrical shortage and fire.
- Do not install the product in an unstable place or on a small stand. The product may cause serious injury, if it falls on somebody (especially children). Install it on an even, stable place as it is front-heavy.
- Do not install the product on the floor. Someone (especially children) may trip over it.

Usage

- Unplug the product from the wall outlet and do not touch the antenna during a thunderstorm. This will prevent damage to the unit due to lightning and power-surges.
- Keep dust or water away from the pins or touching points of the power plug. This will prevent electrical shock or fire.
- Keep children from climbing over the product. The device may cause serious injury or death if it falls on them.
- Do not place anything over the product that children may try to reach. The device may cause serious injury or death if it falls on them.
- When removing the battery from the product, keep it out of children's reach. If a child swallows a battery, consult a doctor immediately.
- Use only specified batteries and do not use an old battery along with a new one. Align the batteries according to the correct polarity (+ or -). Aligning them incorrectly may cause an internal explosion or a leakage of the internal liquid, leading to electrical shock, physical damage or pollution of the surroundings.
- Do not insert any metal or a flammable object or an alien substance into the ventilator, the AV input terminal or the slots for the modules or Smartcards. This may cause damage to the product and reduce its life span.
- Do not disassemble, repair or reconstruct the product at your discretion. This may cause electrical shock or fire. Contact your local customer support.
- Keep the product away from inflammable sprayers or ignitable objects. Exposure to these may cause explosion or fire.
- Do not place water-pots, flower vases, beverage cans, small metals or heavy objects over the product. Contact of these contents with the product may cause electrical shock or fire, while any falling of the product may cause injury.
- If the product breaks down, turn off the power and unplug it from the outlet before contacting Customer Support. This will protect you from electrical shock or fire.
- When you notice something strange like an odd noise, smell something burning or see smoke, unplug the power cord and contact your local Customer Support. Do this to avoid electrical shock or fire.
- Do not use sharp tools such as a pin or a pencil near the TV, as they may scratch the LCD surface.
- Do not use a solvent, such as benzene, to clean the TV, as it will damage the LCD surface.
- Do not move the product or turn the power off suddenly while the hard disk drive is running.
- The company shall not be liable for any corruption of data on the hard disk drive caused by the carelessness or misuse of users.
- Do not separate the hard disk drive from the main body. Contact your local Customer Support when you want to change the hard disk drive.

Contents

Chapter 1 >> Getting Started	8
Package Contents.....	8
Front & Side Panel.....	9
Rear & Side Panel	10
Remote Control Buttons.....	12
Installing TV Wall Mount	16
Chapter 2 >> Connecting Your TV.....	18
Connecting to an Aerial or a Cable TV.....	18
Connecting to the VCR	19
Connecting to the DVD Player	22
Connecting to the Set-Top Box	24
Connecting to the Digital Audio System.....	26
Connecting to the PC.....	26
Connecting Headphones	27
Conditional Access System	27
Chapter 3 >> Turning on Your TV.....	29
Turning on Your TV	29
Selecting the Menu Language	29
Selecting the Main Input Source.....	30
Setting Channels.....	30
Scanning Channels Automatically	30
Scanning Analog Channels Manually.....	31
Scanning Digital Channels Manually.....	32
Editing Programmes.....	32
Viewing Channel List	34
Displaying Information	35
Displaying Digital Teletext (MHEG).....	36
Changing Subtitle Language	36
Changing Audio Options	36
Chapter 4 >> Using the Electronic Programme Guide (EPG)	37
Viewing the Electronic Programme Guide (EPG)	37
Reserving a Recoding.....	38
Chapter 5 >> Setting the Picture	39
Selecting a Picture Mode.....	39
Customizing the Picture Settings.....	39
Noise Reduction.....	40
Fleshtone	40
Dynamic Contrast	41
Colour Temperature	41
Adjusting Backlight Brightness.....	42

Chapter 6 >> Setting the Sound	43
Setting the Sound Effect	43
Adjusting the Sound Balance.....	43
Adjusting the Volume Automatically	44
Setting the TruSurround XT	44
Setting up Audio Priority.....	45
Chapter 7 >> Setting the Screen	46
PIP/PBP/POP Settings	46
Setting the Aspect Ratio.....	48
Chapter 8 >> Setting the System	49
Setting the Current Time Information	49
Parental Control	51
Common Interface	52
Default Settings.....	53
Chapter 9 >> Recording	54
Setting the Recording Quality	54
Time-Shift Recording (TSR).....	54
Instant Recording.....	57
Scheduled recording.....	57
Programme Playback.....	59
Checking Hard Disk Drive.....	62
Chapter 10 >> Teletext information	63
Displaying Teletext information	63
Chapter 11 >> Connecting a PC.....	64
Auto Configure	64
Position	64
Clock	65
Phase.....	65
Chapter 12 >> Software Update.....	66
OTA (Over the Air).....	66
S/W Update from PC	68
Menu Structure	69
Troubleshooting.....	70
Troubleshooting	70
Error Message	71
Specification	72
Service and Support.....	73

Package Contents

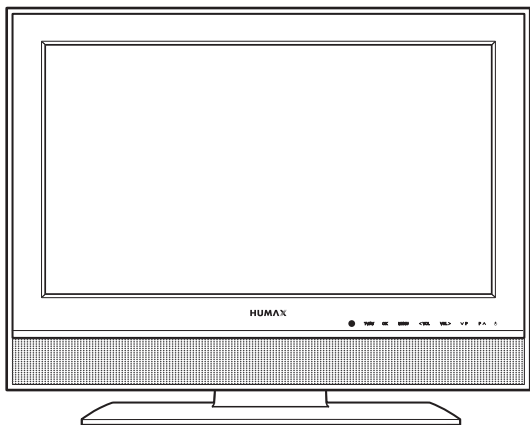

LCD TV



User's manual

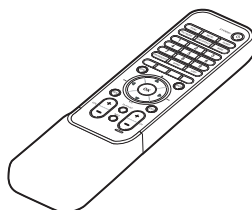

Remote control

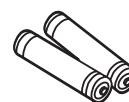

AAA batteries (X2)



Power cord

Front & Side Panel

LED touch buttons are displayed on the front panel. You can simply touch LED buttons to control some main functions such as selecting a main input, using the OK command, displaying menus, adjusting volume, and switching channels.

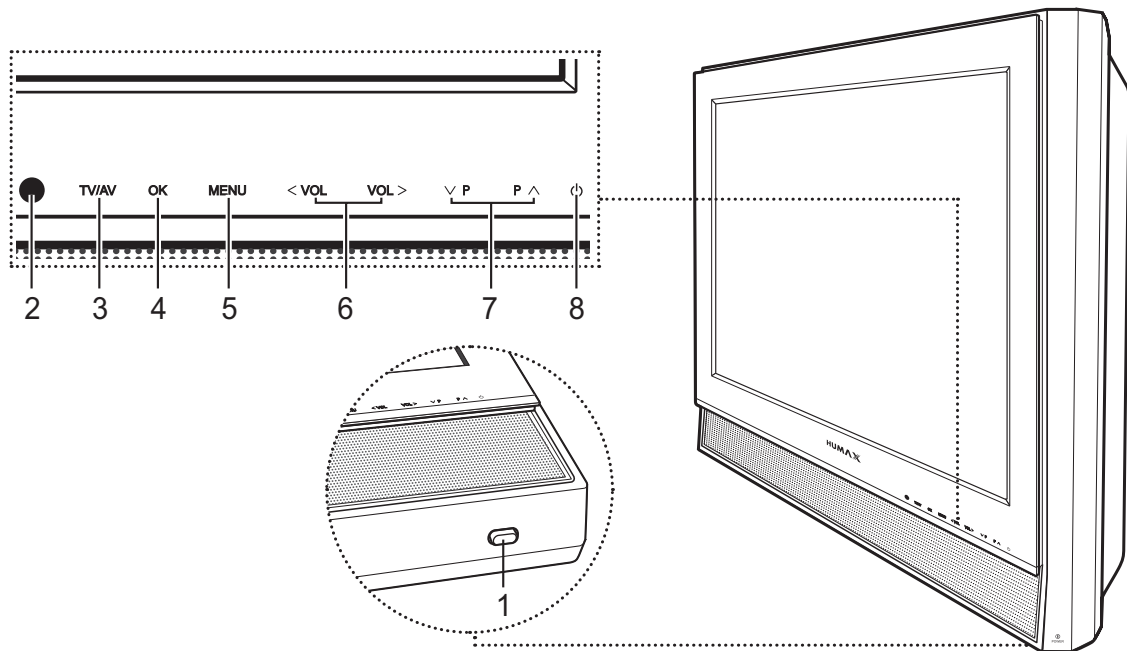

- 1 POWER switch**
Turns the power on/off.
- 2 Remote control sensor**
Receives commands directly from your remote control and passes them on.
- 3 TV/AV button**
Displays input source.
- 4 OK button**
Confirms the selection.
- 5 MENU button**
Displays the on-screen menu.
- 6 < VOL / VOL > buttons**
Adjusts the volume.
- 7 √ P / P ^ buttons**
Selects channels.
- 8 Standby button**
Sets your TV in standby mode and turns on blue during the standby mode.

Rear & Side Panel

Side Panel

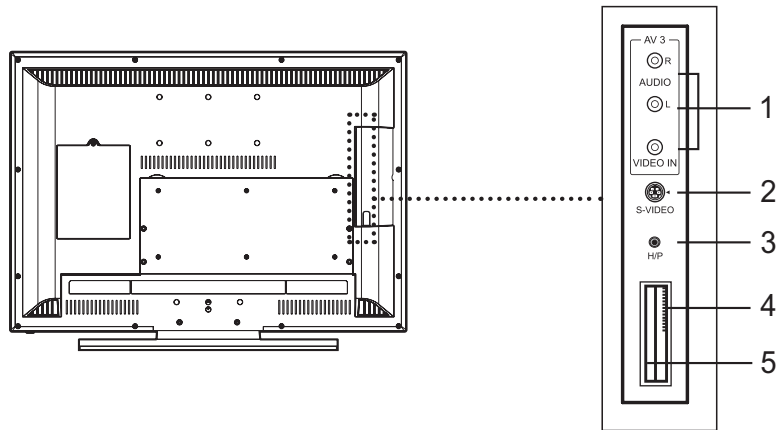

1 AV3 (CVBS) INPUT

Connects to the audio and video output jacks of a camcorder, videogame and similar devices.

2 S-VIDEO INPUT

Connects to the S-Video jack of a camcorder, video game console, and similar devices.

3 H/P (Headphones)

Connects to headphones.

4 CI (Common Interface) SLOT

A slot for a CI Module.

5 SMARTCARD SLOT

A slot for a Smartcard. (Ready for future use)

Rear Panel

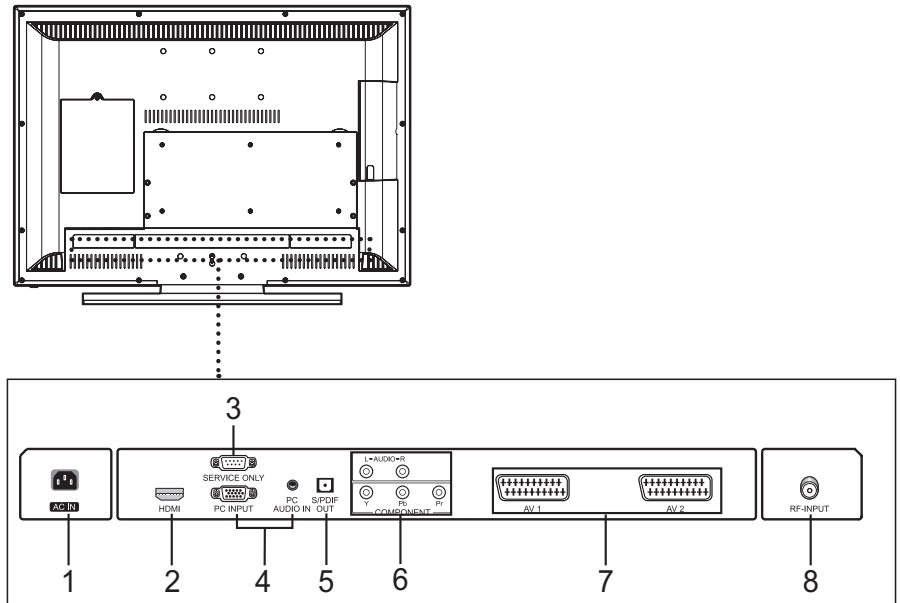

- 1 AC INPUT**
Connects the power cord.
- 2 HDMI INPUT**
Receives uncompressed digital audio and video signals from the device that supports High Definition Multi-media Interface (HDMI).
- 3 SERVICE ONLY (RS232C)**
Connects to the PC to update the software of the TV.
- 4 PC INPUT/PC AUDIO INPUT**
Connects to the video and audio output jacks on your PC.
- 5 S/PDIF OUTPUT**
Connects to a digital audio component. (digital audio output only)
- 6 COMPONENT INPUT**
Connects to Video (Y/PB/PR) and audio (L/R) components.
- 7 AV1/AV2 (SCART1/SCART2)**
Inputs or outputs for external devices, such as VCR, DVD, video game console or video disc players. AV1 jack outputs only Analog TV signal and AV2 jack outputs Digital TV, Analog TV, AV1, AV2, AV3 or S-Video input signal.
- 8 RF INPUT**
Connects to an antenna or a cable system.

Remote Control Buttons

Number (0~9) buttons

Enters the channel number for direct display. Used to enter digit numbers.

FAV

Switches to a favourite channel. Circulates through favourite channels in sequent order while watching TV.

LIST

Displays channel lists. Press the ▲/▼ button to select a channel.

Coloured buttons

Used for interactive applications in the EPG, Edit Programmes, Schedule, Playlist and Teletext mode.

EPG

Displays the Electronic Programme Guide (EPG) in DTV mode.

BACK

Returns to the previous display.

MENU

Displays the On Screen Display (OSD) menu.

EXIT

Exits from the currently displayed menu.

Arrow (▲/▼/◀/▶) buttons

Controls the selection in the On Screen Display (OSD) menu.

OK

Confirms (save or enter) your choice in the On Screen Display (OSD) menu. Displays the setting status of the current screen.

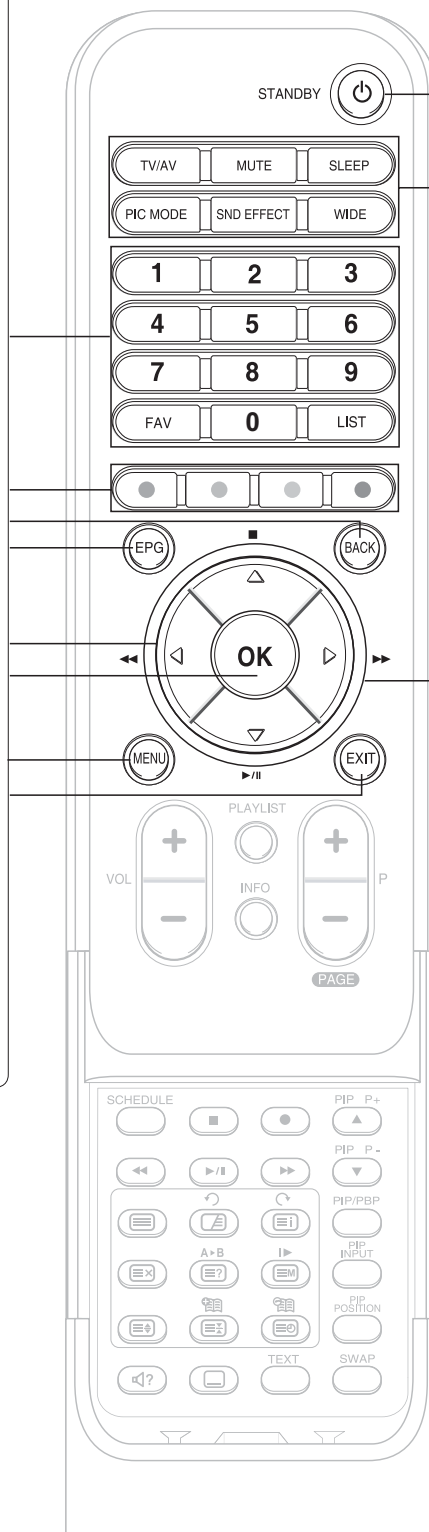

STANDBY

Puts your TV in standby mode.

MUTE

Mutes the sound. To cancel, press the MUTE, VOL+, or VOL- button.

TV/AV

Displays all available input sources. Press the ▲/▼ button to select a required input source.

SLEEP

Selects a preset time interval for switching the TV to standby mode automatically.

PIC MODE

Selects the picture mode (Standard, Dynamic, Movie, Mild, Game, or User).

SND EFFECT

Selects sound modes (Flat, Speech, Movie, Music, or User).

WIDE

Select the aspect ratio (Auto, 4:3, 14:9, 16:9, Zoom1, or Zoom2).

PLAYBACK Control Buttons

■ (STOP)

Stops recording or playback and go to the live programme.

▶/II (PLAY/PAUSE)

Plays at normal speed or pauses the live programme.

▶▶ (FAST FORWARD)

Fast forward at high speed. Each time you press this button the fast forwarding speed increases.

◀◀ (FAST REWIND)

Rewinds at high speed. Each time you press this button the fast rewinding speed increases.

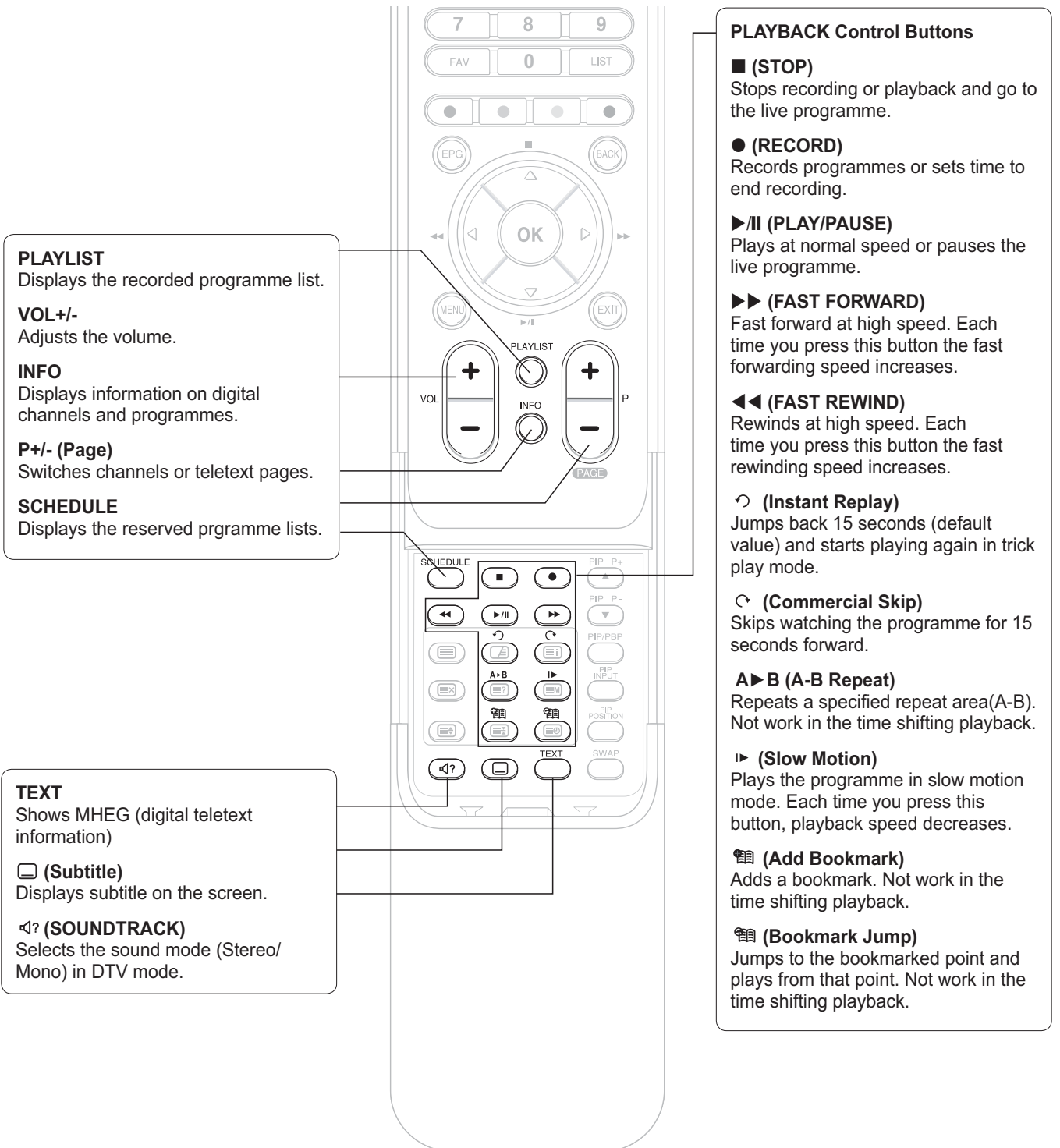

PLAYLIST
Displays the recorded programme list.

VOL+/-
Adjusts the volume.

INFO
Displays information on digital channels and programmes.

P+/- (Page)
Switches channels or teletext pages.

SCHEDULE
Displays the reserved programme lists.

TEXT
Shows MHEG (digital teletext information)

(Subtitle)
Displays subtitle on the screen.

(SOUNDTRACK)
Selects the sound mode (Stereo/ Mono) in DTV mode.

PLAYBACK Control Buttons

■ **(STOP)**
Stops recording or playback and go to the live programme.

● **(RECORD)**
Records programmes or sets time to end recording.

▶/|| **(PLAY/PAUSE)**
Plays at normal speed or pauses the live programme.

▶▶ **(FAST FORWARD)**
Fast forward at high speed. Each time you press this button the fast forwarding speed increases.

◀◀ **(FAST REWIND)**
Rewinds at high speed. Each time you press this button the fast rewinding speed increases.

↺ **(Instant Replay)**
Jumps back 15 seconds (default value) and starts playing again in trick play mode.

↻ **(Commercial Skip)**
Skips watching the programme for 15 seconds forward.

A▶B (A-B Repeat)
Repeats a specified repeat area(A-B). Not work in the time shifting playback.

▶ **(Slow Motion)**
Plays the programme in slow motion mode. Each time you press this button, playback speed decreases.

📌 **(Add Bookmark)**
Adds a bookmark. Not work in the time shifting playback.

📌 **(Bookmark Jump)**
Jumps to the bookmarked point and plays from that point. Not work in the time shifting playback.

TELETEXT Function Buttons

(Teletext On/Off)

Activates or deactivates the teletext service.

(Mix)

Overlaps the teletext with the broadcasting screen.

Adjusts the opacity to the background in Teletext mode.

(Index)

Displays the teletext index page.

(Cancel)

Displays the TV programme when searching for the new teletext page.

(Reveal)

Shows the hidden information.

(Mode)

Selects the teletext mode (LIST/FLOF)

(Size)

Displays the double-size letters.

(Hold)

Holds the current teletext page not updating it.

(Time)

When viewing a TV programme, press this button to display the current time at the top right hand corner of the screen.

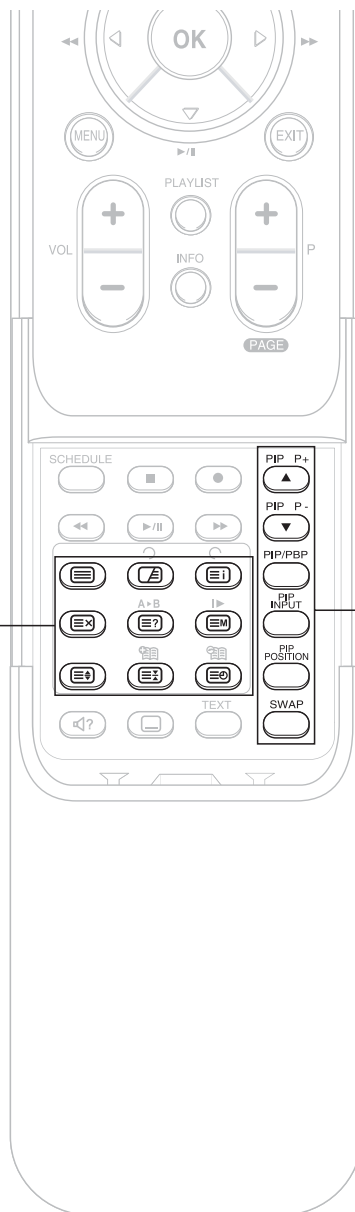

PIP/PBP Function buttons

PIP P+/PIP P-

Switches sub-picture channels.

PIP/PBP

Selects the PIP/PBP mode (Off, PIP Small, PIP Large, PBP1, PBP2, or POP).

PIP INPUT

Selects an input source for the sub picture.

PIP POSITION

Changes the position of the PIP screen.

SWAP

Swaps the main picture and the sub-picture.

■ Inserting Batteries into the Remote Control

You must insert or replace the batteries in the remote control when:

- + You just purchased TV
- + Remote control does not work

- 1 Remove the cover on the rear of the remote control by pressing the symbol (▼) downwards and then pulling firmly to remove it.
- 2 Insert two AAA size 1.5V batteries ensuring that the plus(+) and minus(-) signs of the batteries are correctly aligned.
- 3 Close the cover.

Note: Do not mix different battery types such as alkaline with manganese.

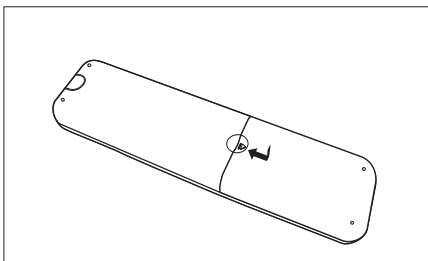
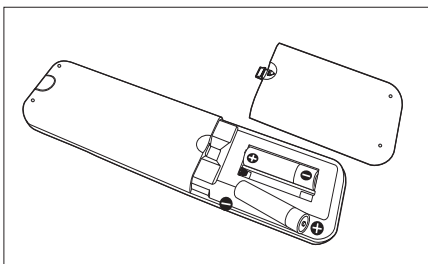
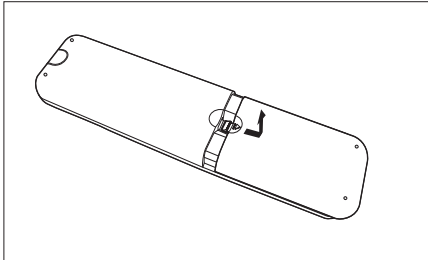

Installing TV Wall Mount

■ Installation Method

- TV wall mount is sold separately.
- Install the TV on a vertical wall only.
- To avoid troubles during the installation, refer to the followings:
 - Do not install next to smoke and fire detectors.
 - Do not install in an area subjected to vibration or high voltage.
 - Do not install near or around any heating apparatus.
 - Only use recommended parts and components.

■ Mounting Kits (sold separately)

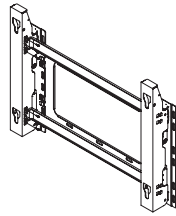

Wall Mount Bracket



Plastic Hanger (6EA)

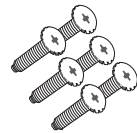

Screws (6EA)

How to Attach the TV to the Bracket (sold separately)

The exterior of the TV may be different than the picture. (Assembly and installation of the plastic hanger is the same.)

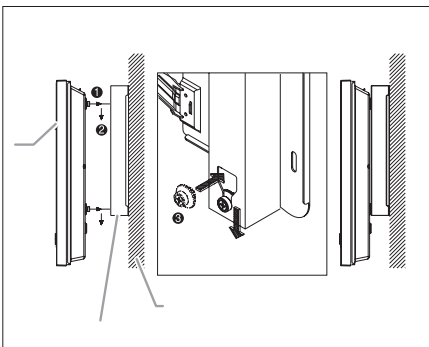
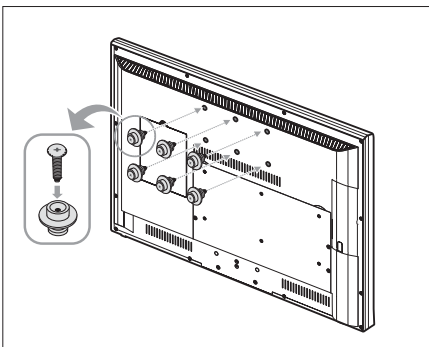
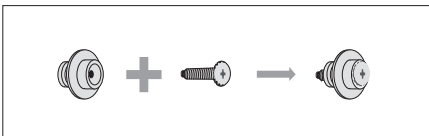
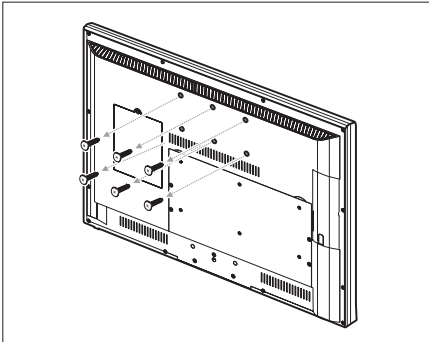

- 1 Remove the screws from the rear of the TV.
- 2 Use the screws and assemble the plastic hanger.
(Ask a mechanic for installing the wall mount bracket.)
(Please be sure to check if the plastic hanger is completely secured on the left and right side after hanging the TV on the wall mount bracket.)
 - Please be careful not to harm your fingers while installing and adjusting the angle.
 - Please secure the wall mount bracket to the wall to avoid injury from a falling TV.
- 3 Tighten the screws of the plastic hanger to the rear of the TV.
- 4 Put the 6 pegs on TV in the grooves of the wall mount bracket and pull down on TV [1] to secure it to the wall mount bracket [2]. Tighten the screws as shown [3] so that the TV cannot be separated from the wall mount bracket.

Connecting to an Aerial or a Cable TV

To view the television channels correctly, a signal must be received by the broadcasting provider.

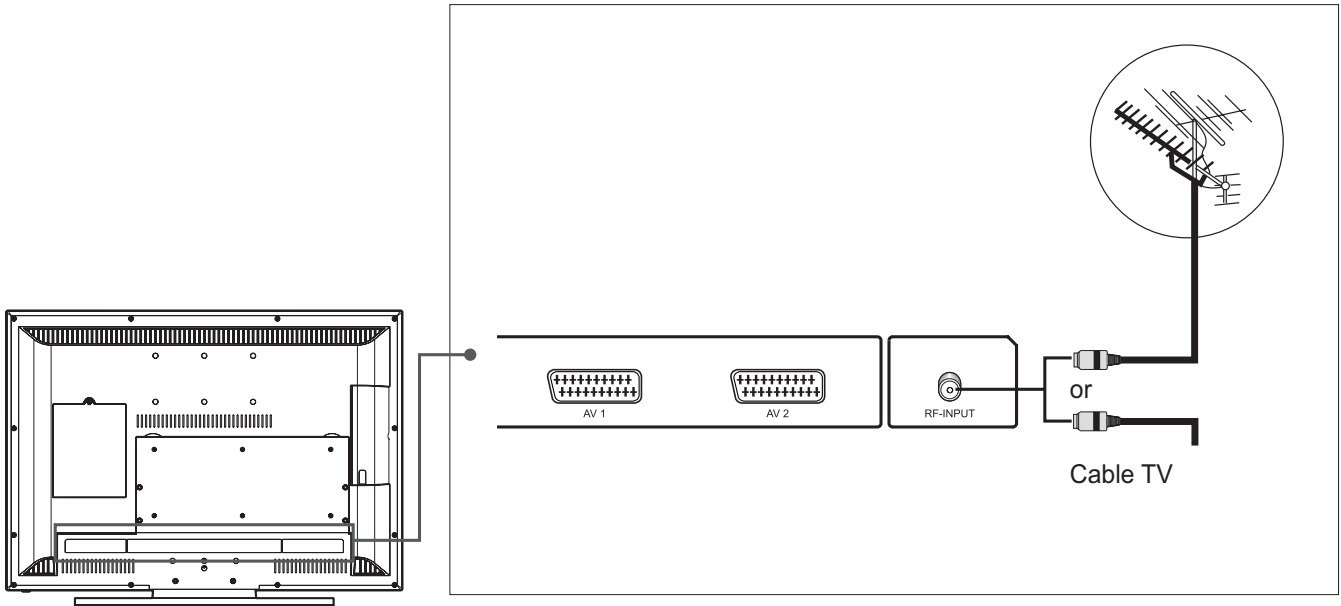

- 1 Connect the RF coaxial cable from an aerial or a cable TV to the **RF-INPUT** jack on the rear of the TV.
- 2 Turn on the TV, and then press the **TV/AV** button to select **Digital TV** or **Analog TV**.

Notes:

1. To receive an optimal signal, it is recommended that you use a 75 ohm F-type coaxial cable.
2. For proper reception of signals, an external antenna is required. For best reception, an outdoor antenna is recommended.
3. To improve the picture quality in a poor signal area, please purchase a signal amplifier and install properly.

Connecting to the VCR

Using the SCART Cable

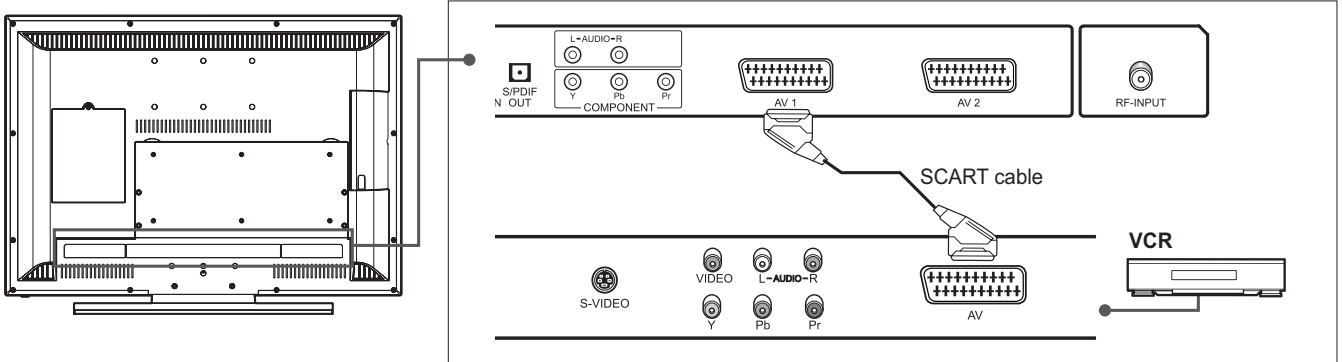

- 1 Connect the SCART cable between the **AV1** (or **AV2**) jack on TV and the SCART jack on your VCR.
- 2 Turn on the TV, and then press the **TV/AV** button to select **AV1** (or **AV2**).
- 3 Turn on your VCR, then insert a video cassette into the VCR and press the **PLAY** button on your VCR. (Refer to the VCR owner's manual)

If you want to make a copy from a secondary VCR (or DVD player)

- 1 Connect your secondary VCR (or DVD player) to the **AV1** jack and the target VCR (or DVD player) to the **AV2** jack so that the signal transfers from **AV1** to **AV2**.
- 2 To record a programme, connect the receiver to the **AV1** jack and the VCR (or DVD player) to the **AV2** jack so that the signal transfers from **AV1** to **AV2**.

Note: For more details about how to record, refer to your required Equipment's instructions.

Main Input	AV1 (SCART 1) Output	AV2 (SCART 2) Output	
Digital TV	Analog TV	Digital TV	
Analog TV		Analog TV	
AV1		AV1	
AV2		AV2	
AV3(CVBS)		AV3(CVBS)	
S-Video		S-Video	
Component		Digital TV	Digital TV
PC			
HDMI			

Using the Audio/Video (Composite) Cable

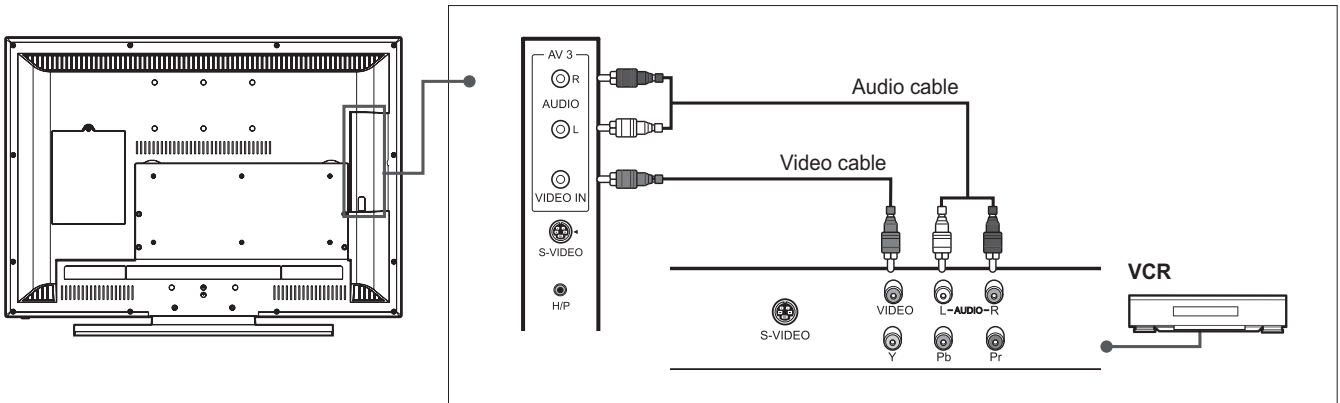

- 1 Connect the video cable between the **VIDEO IN(AV3)** input jack on TV and the video output jack on your VCR.
- 2 Connect the audio cable between the **AUDIO-L/R (AV3)** input jacks on TV and the audio output jacks on your VCR.
- 3 Turn on the TV, and then press the **TV/AV** button to select **AV3(CVBS)**.
- 4 Turn on your VCR, then insert a video cassette into the VCR and press the **PLAY** button on the VCR. (Refer to the VCR owner's manual)

Using the Audio/S-Video Cable

S-Video carries the video data as two separate signals (brightness and colour), unlike composite video which carries the entire set of signals in one package. S-Video does not carry audio. Hence, a separate audio connection is required.

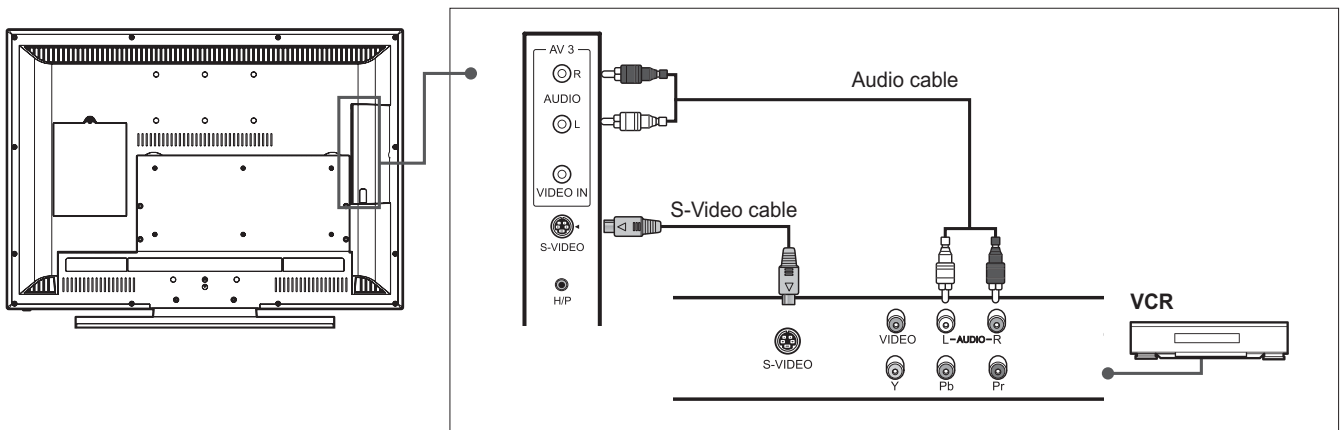

- 1 Connect the S-Video cable between the **S-VIDEO** input jack on TV and the S-Video output jack on your VCR.
- 2 Connect the audio cable between the **AUDIO-L/R (AV3)** input jacks on TV and the audio output jacks on your VCR.
- 3 Turn on the TV, and then press the **TV/AV** button to select **S-Video**.
- 4 Turn on your VCR, then insert a video cassette into the VCR and press the **PLAY** button on your VCR. (Refer to the VCR owner's manual)

Connecting to the DVD Player

Using the SCART Cable

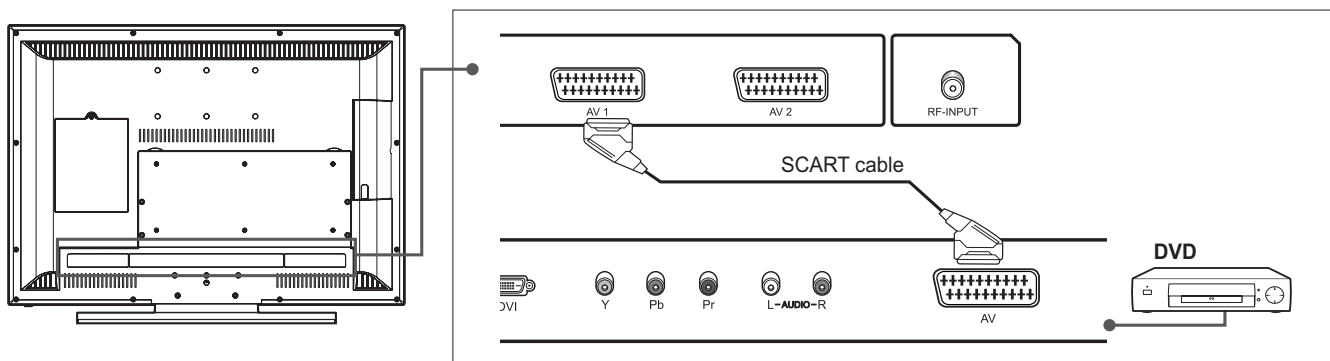

- 1 Connect the SCART cable between the **AV1** (or **AV2**) jack on TV and the SCART jack on your DVD player.
- 2 Turn on the TV, and then press the **TV/AV** button to select **AV1** (or **AV2**).
- 3 Turn on your DVD player, and then insert a DVD into the DVD player and press the **PLAY** button on your DVD player. (Refer to the DVD player owner's manual)

Using the Audio/Component Video Cable

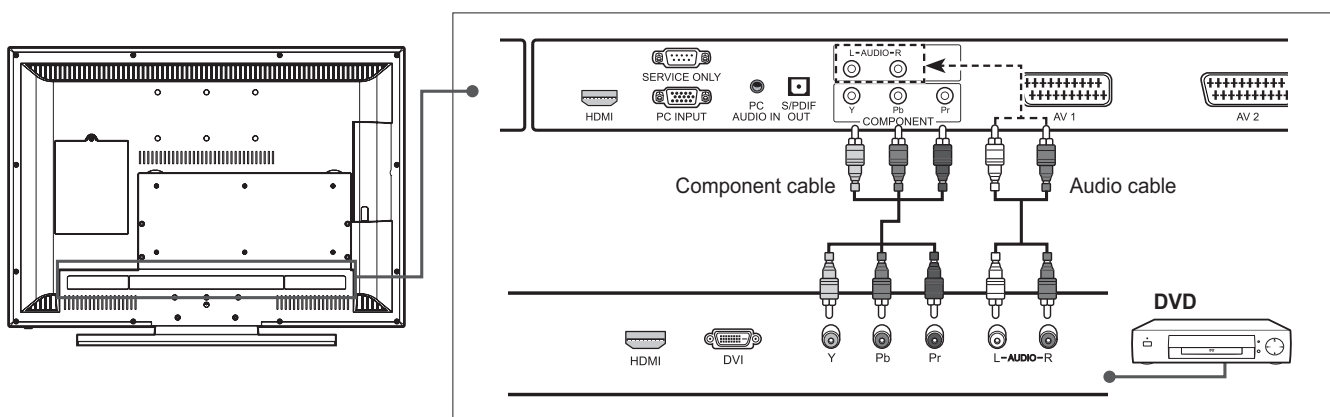

- 1 Connect the component video cables between the **COMPONENT VIDEO - Y/Pb/Pr** input jacks on TV and the component video output jacks on your DVD player.
- 2 Connect the audio cable between the **AUDIO-L/R** (for COMPONENT) input jacks on TV and the audio output jacks on your DVD player.
- 3 Turn on the TV, and then press the **TV/AV** button to select **Component**.
- 4 Turn on your DVD player, then insert a DVD into the DVD player and press the **PLAY** button on your DVD player. (Refer to the DVD player owner's manual)

Note: Depending on the manufacturer, the Y/Pb/Pr jacks may be identified as Y/P_B/P_R, Y/B-Y/R-Y or Y/C_B/C_R.

Using the HDMI Cable

High-Definition Multimedia Interface (HDMI) is the leading new standard for Digital video and audio interconnection.

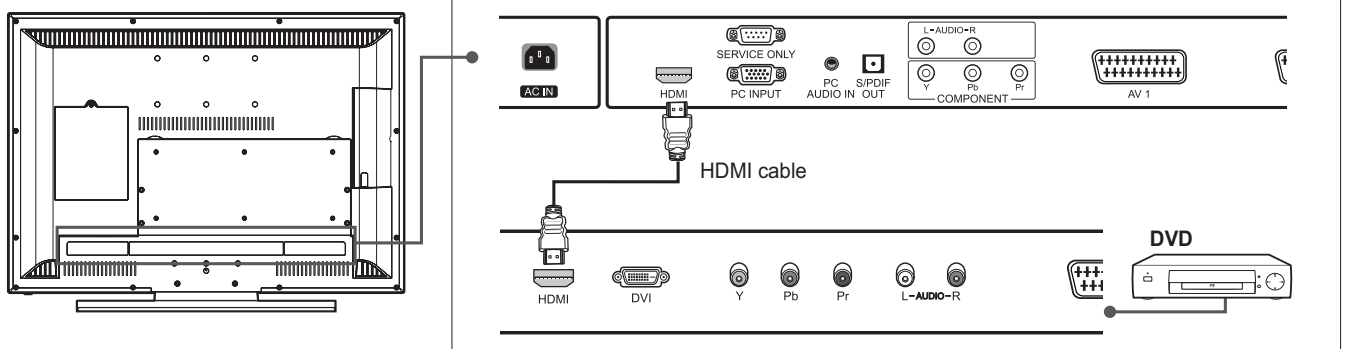

- 1 Connect the HDMI cable between the **HDMI** input jack on TV and the HDMI output jack on your DVD player.
- 2 Turn on the TV, and then press the **TV/AV** button to select **HDMI**.
- 3 Turn on your DVD player, then insert a DVD into the DVD player and press the **PLAY** button on your DVD player. (Refer to the DVD player owner's manual)

Using the HDMI to DVI Adapter

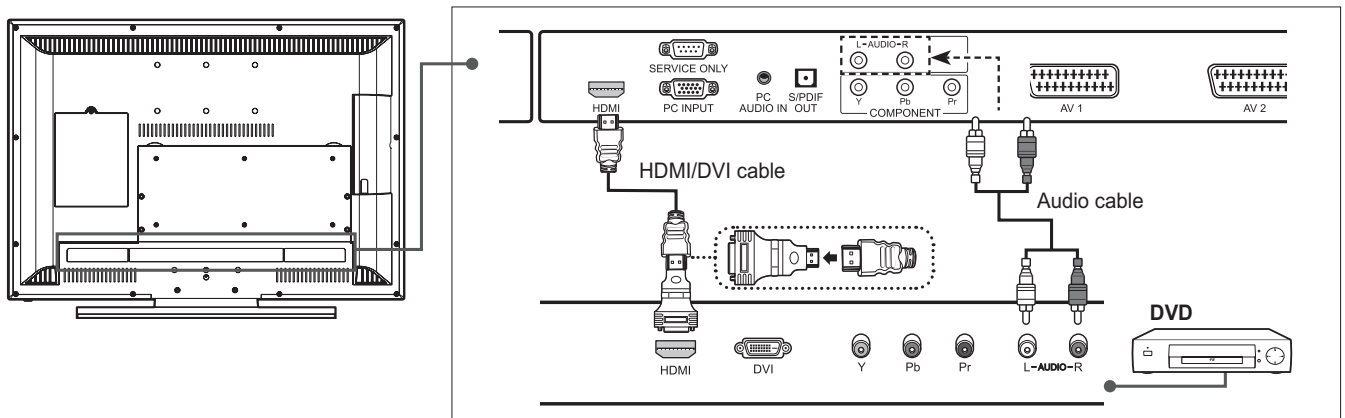

- 1 Connect the HDMI cable between the **HDMI** input jack on the TV and HDMI jack on the HDMI to DVI adapter.
- 2 Connect the HDMI to DVI adapter to the DVI output jack on the DVD player.
- 3 Connect the audio cable between the **AUDIO-L/R**(for COMPONENT) input jacks on TV and the audio output jacks on your DVD player.
- 4 Turn on the TV, and then press the **TV/AV** button to select **HDMI**.
- 5 Turn on your DVD player, then insert a DVD into the DVD player and press the **PLAY** button on the DVD player. (Refer to the DVD player owner's manual)

Connecting to the Set-Top Box

Using the SCART cable

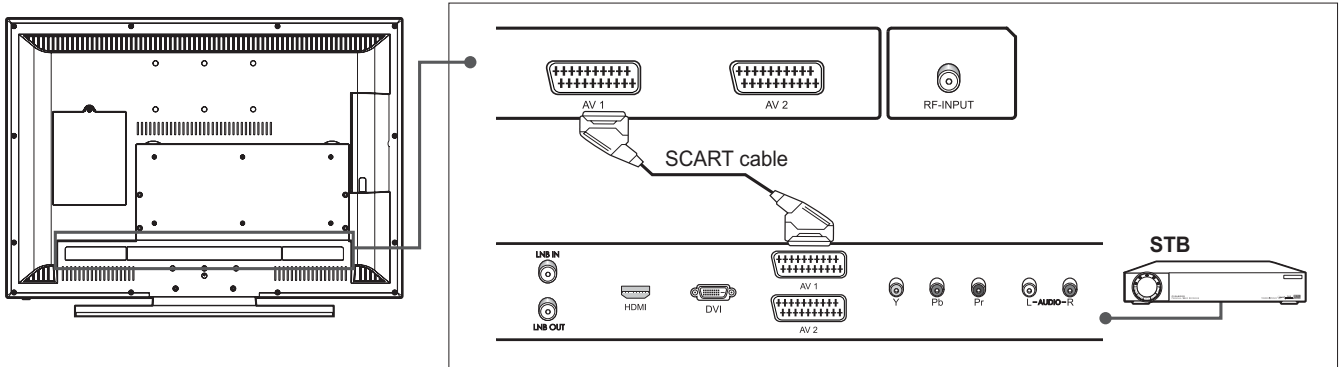

- 1 Connect the SCART cable between the **AV1** (or **AV2**) jack on TV and the SCART jack on your STB.
- 2 Turn on the TV, and then press the **TV/AV** button to select **AV1** (or **AV2**).
- 3 Turn on your STB. (Refer to the STB owner's manual)

Using the Audio/Component Video Cable

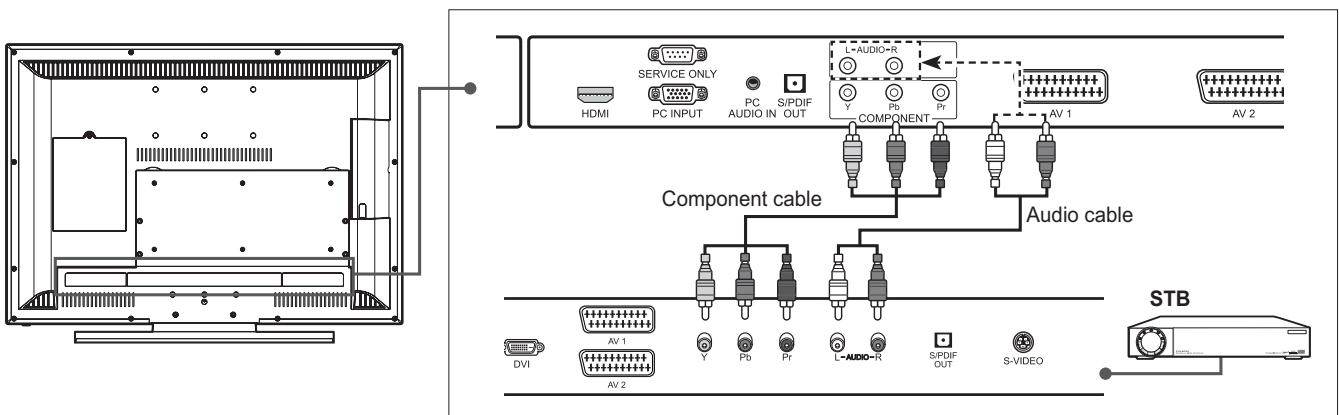

- 1 Connect the component video cables between the **COMPONENT VIDEO - Y/Pb/Pr** input jacks on TV and the component video output jacks on your STB.
- 2 Connect the audio cable between the **AUDIO-L/R** (for **COMPONENT**) input jacks on TV and the audio output jacks on your STB.
- 3 Turn on the TV, and then press the **TV/AV** button to select **Component**.
- 4 Turn on your STB. (Refer to the STB owner's manual)

Note: Depending on the manufacturer, the Y/Pb/Pr jacks may be identified as Y/P_B/P_R, Y/B-Y/R-Y or Y/C_B/C_R.

Using the HDMI Cable

High-Definition Multimedia Interface (HDMI) is the leading new standard for Digital video and audio interconnection.

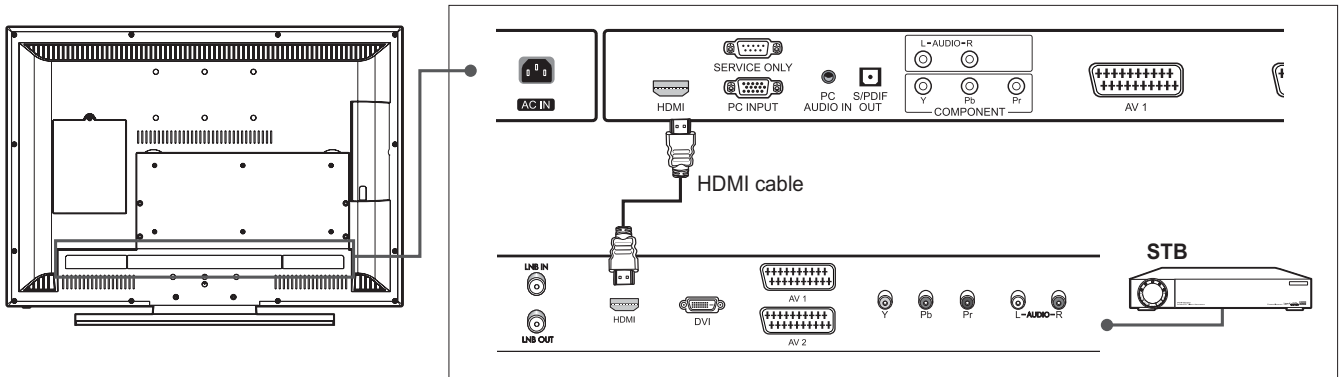

- 1 Connect the HDMI cable between the **HDMI** input jack on TV and the HDMI output jack on your STB.
- 2 Turn on the TV, and then press the **TV/AV** button to select **HDMI**.
- 3 Turn on your STB. (Refer to the STB owner's manual)

Using the HDMI to DVI Adapter

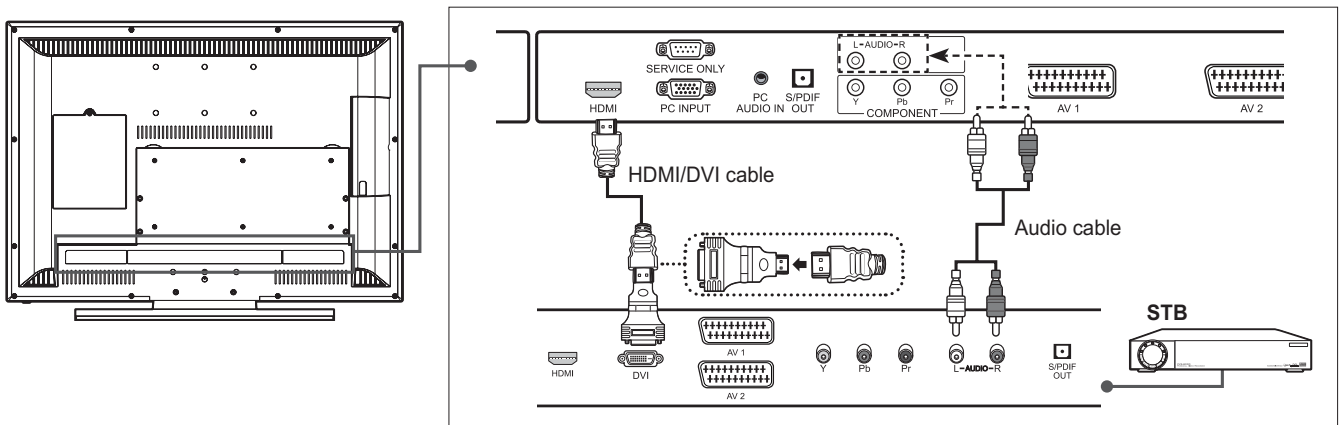

- 1 Connect the HDMI cable between the **HDMI** input jack on the TV and HDMI jack on the HDMI to DVI adapter.
- 2 Connect the HDMI to DVI adapter to the DVI output jack on the STB.
- 3 Connect the audio cable between the **AUDIO-L/R** (for COMPONENT) input jacks on TV and the audio output jacks on your STB.
- 4 Turn on the TV, and then press the **TV/AV** button to select **HDMI**.
- 5 Turn on your STB. (Refer to the STB owner's manual)

Connecting to the Digital Audio System

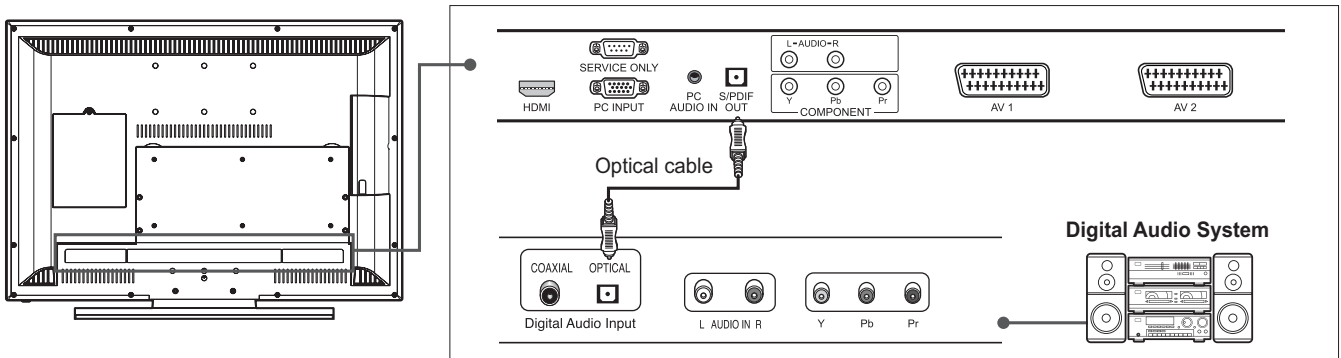

- 1 Connect the optical cable between the **S/PDIF OUT** jack on TV and the optical input jack on your digital audio system.
- 2 Turn on the TV and your Digital Audio System, and then adjust the volume. (Refer to the Digital Audio System owner's manual)

Note: In order to enjoy the sound from the Digital Audio System, press the **VOL+/-** button or **MUTE** button to minimise the volume or to cut off the sound from the TV.

Connecting to the PC

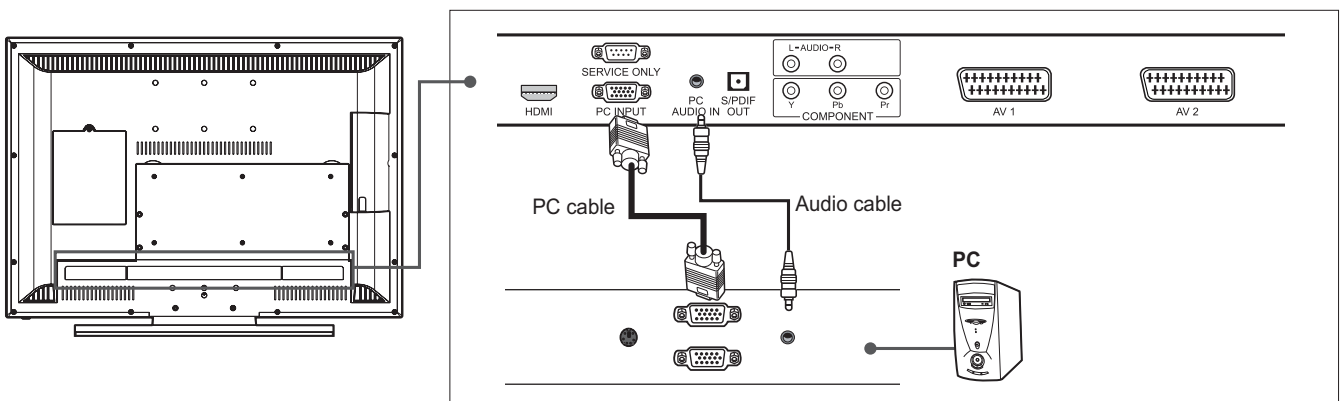

- 1 Connect the PC cable between the **PC INPUT** jack on TV and the PC output jack on your PC.
- 2 Connect the audio cable between the **PC AUDIO IN** jack on TV and the audio output jack on your PC.
- 3 Turn on the TV, and then press the **TV/AV** button to select **PC**.

Connecting Headphones

Connect a set of headphones to **H/P** jack on TV if you want to watch a television programme without disturbing other people close to you.

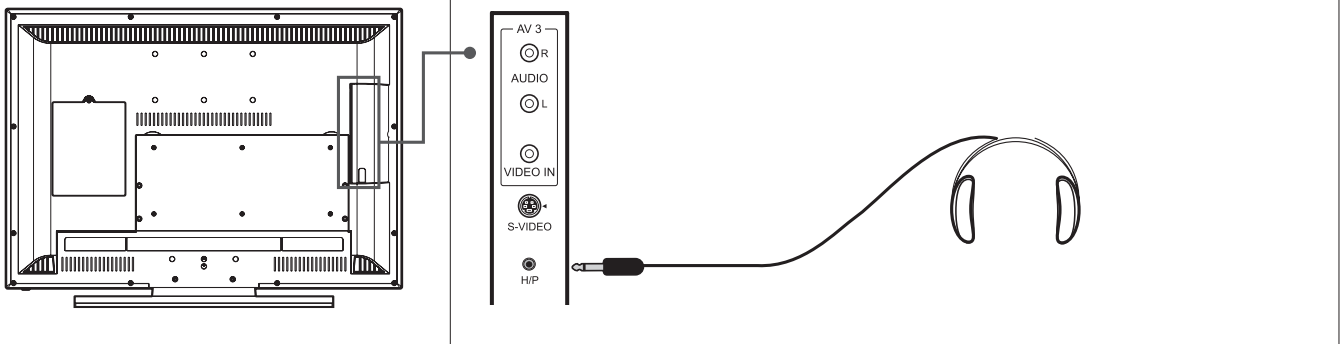

Note: Prolonged use of headphones at a high volume may cause health damage on your ears.

Conditional Access System (for the digital channels only)

Conditional Access System (CAS) is a technology used to control access to digital television (DTV) services to authorised users by encrypting the transmitted programming.

Inserting a Smartcard (Ready for future use)

Insert the Smartcard into the slot at rear flap of your TV. A valid Smartcard enables you to access to all the channels you subscribe to.

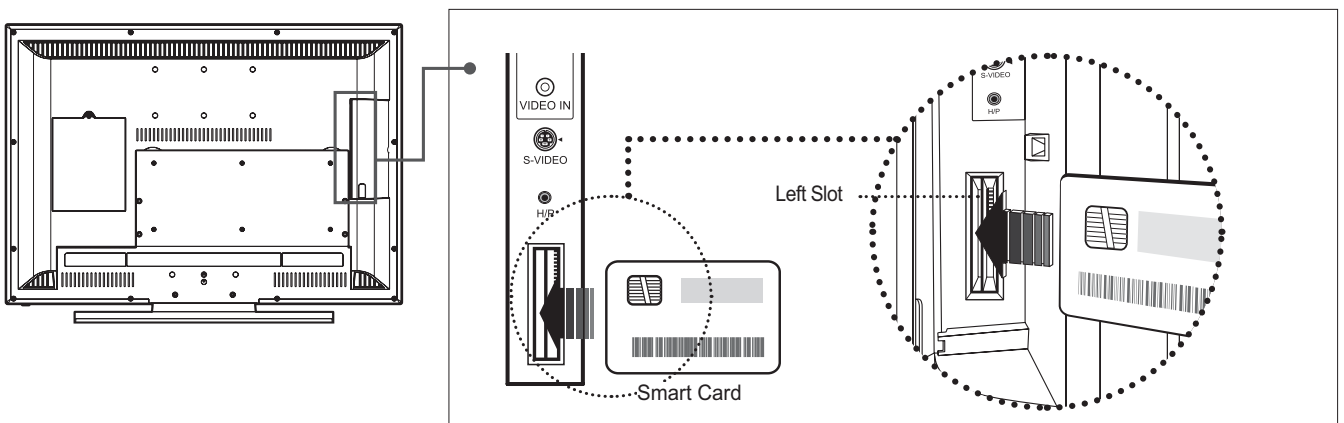

- 1 Open the rear flap of your TV.
- 2 Hold the Smartcard with the electronic chip facing backwards to your TV.
- 3 Insert the Smartcard into the left slot until the card is completely in.

■ Inserting a CI Module (with Smartcard)

CI Module looks like a PC Card (called PCMCIA) for laptops. There are different kinds of CI Modules, suitable for different coding systems.

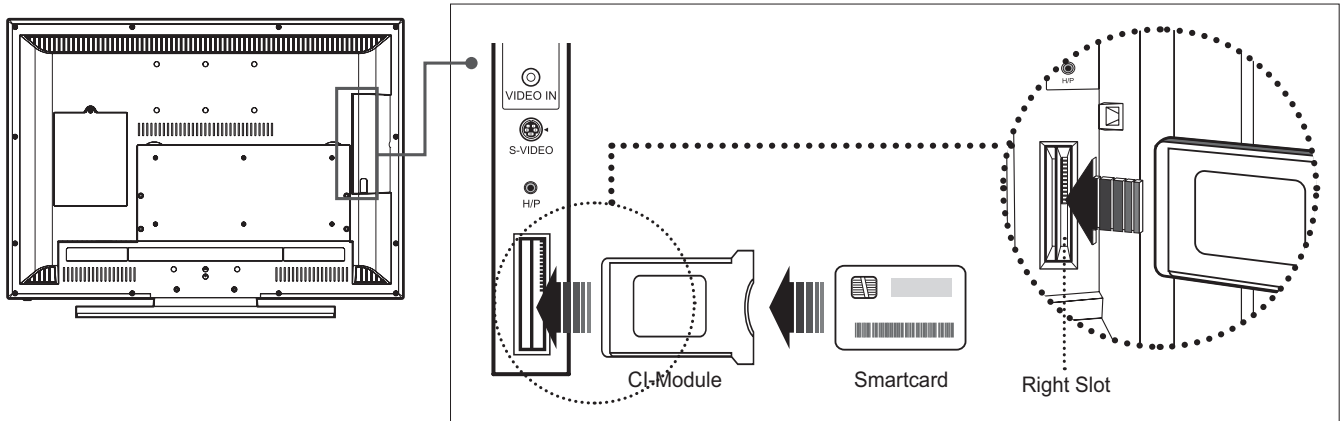

- 1 Open the rear flap of your TV.
- 2 Follow the instructions of the module and insert the Smartcard into the Common Interface (CI) module.
- 3 Keep the CI module (with the Smartcard) vertically.
- 4 Insert the CI module completely into the right slot.

Note: Ensure the Smartcard or CI module is inserted in the right direction. Inserting in the wrong direction may cause damage to the Smartcard or CI module.

Turning on Your TV

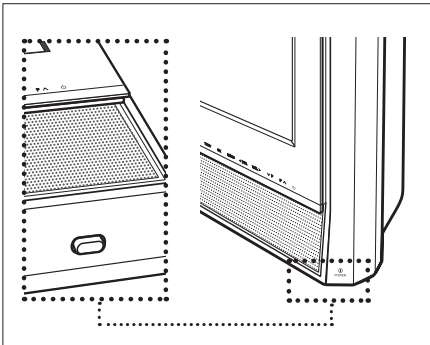

To turn on your TV, do as follows:

- 1 Connect the power cord on TV to the wall outlet.
- 2 Press the **POWER** switch on the front of your TV. The standby indicator lights up.
- 3 Press the **STANDBY** button on your remote control (or on the front of your TV) to turn on the TV.

Note: To set your TV in standby mode, press the **STANDBY** button again on the remote control or (⏻) on the front of your TV. It saves the electric usage when you want to stop watching TV temporarily (during a meal, for example).

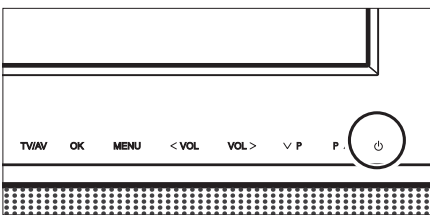

- 4 To turn off the TV, press the **POWER** switch on the front of your TV.

Note: Do not leave your TV in standby mode for too long (on holiday, for example). Turn off the TV by pressing the **POWER** switch on the front of your TV. It is recommended for you to turn off the power by disconnecting the power cord.

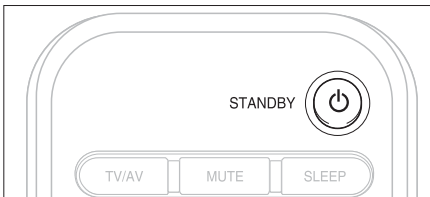

Selecting the Menu Language

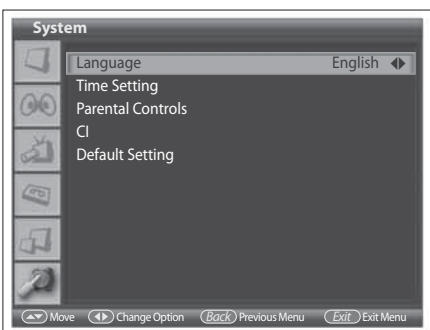

When you start using your TV for the first time, you must select the language for displaying menus and indications.

- 1 Press the **MENU** button.
- 2 Select **System** using the ▲/▼ button and press the **OK** or ► button.
- 3 Select the language of your choice using the ◀/▶ button. The On Screen Display (OSD) menu will be shown in the selected language.
- 4 Press **EXIT** button to return to Live TV or press the **BACK** button to return to the previous menu.

Selecting the Main Input Source

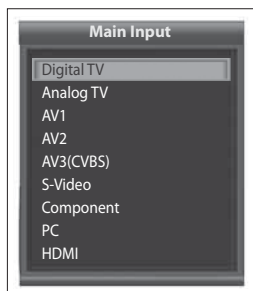

Once you have connected your various audio and video systems, you can view different sources by selecting input sources.

- 1 Press the **TV/AV** button.
- 2 Select the main input among the sources below using the ▲ or ▼ button.
Digital TV > Analog TV > AV1 > AV2 > AV3(CVBS) > S-Video > Component > PC > HDMI
- 3 Press the **OK** button.



Setting Channels

Scanning Channels Automatically

You can automatically scan channels for the frequency ranges available (availability depends on your region).

*Please make sure the **Main Input** is set to **Digital TV** or **Analog TV** using the **TV/AV** button.*



- 1 Press the **MENU** button
- 2 Select **Channel** using the ▲/▼ button and press the **OK** or ► button.
- 3 Select **Country** using the ▲/▼ button.
- 4 Select the country where you are now located using the ◀/▶ button.
- 5 Select **Auto Programme** using the ▲/▼ button and press the **OK** or ► button.

It starts to scan channels. First scans analog and then digital channels. The scanned channels are automatically saved in order. To stop scanning channels, press the **OK** or **BACK** button.

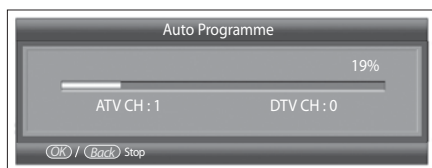

Note: After the channel scanning completes, it returns to the previous watching mode, analog or digital TV mode. It depends on what kind of main input you have set to watch.

Scanning Analog Channels Manually

You can save each channel name and programme number as you identify. Please make sure the **Main Input** is set to **Analog TV** using **TV/AV** button. Analog channels can be scanned only in **Analog TV** input mode.

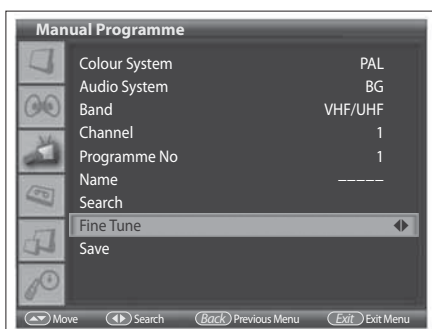
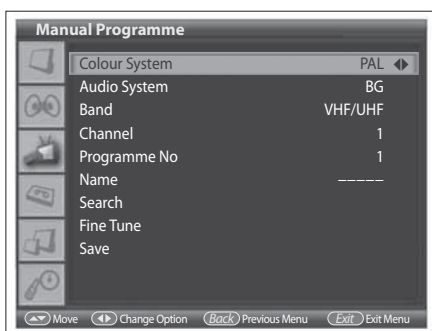

- 1 Press the **MENU** button.
- 2 Select **Channel** using the **▲/▼** button and press the **OK** or **▶** button.
- 3 Select **Manual Programme** using the **▲/▼** button and press the **OK** or **▶** button.
Colour System is highlighted.
- 4 Select the required broadcasting standard (**Auto**, **PAL**, or **SECAM**) using the **◀/▶** button.
- 5 Select **Audio System** using the **▲/▼** button.
- 6 Select the required audio system (**BG**, **I**, **DK**, or **L**) using the **◀/▶** button.
- 7 Select **Band** using the **▲/▼** button.
- 8 Select the required signal source (**VHF/UHF** or **Cable**) using the **◀/▶** button.
- 9 Select **Channel** using the **▲/▼** button and choose the channel number pressing the **◀/▶** or **NUMBER (0~9)** button.
- 10 Select **Programme No** using the **▲/▼** button and select the programme number you would like to assign by pressing the **◀/▶** or **NUMBER (0~9)** button.
- 11 To change channel names, select **Name** using the **▲/▼** button and press the **OK** or **▶** button. The keyword menu appears.
- 12 Enter the new channel name using the **▲/▼/◀/▶** buttons and press the **OK** button.
 - **[OK]**: Completes input.
 - **[Cancel]**: Cancels input.
 - **[Previous]/ [Next]**: Switches displayed text to a special character upper, lowercase, Extend1, or Extend2 etc.,
 - **[←]**: Moves back one space from the current position and deletes a character.
- 13 Select **Search** using the **▲/▼** button and press the **◀/▶** button to start searching channels.
- 14 Select **Fine Tune** using the **▲/▼** button and press the **◀/▶** button to obtain a good quality of the picture and sound until you reach the optimal setting.
- 15 Select **Save** and press the **OK** button to confirm.

Channel mode display

- **C (Air channel mode)**: You can select channels by entering the assigned number for broadcasting stations on air in this mode.
- **S (Cable channel mode)**: You can select a channel by entering the assigned number for cable channels in this mode.

Scanning Digital Channels Manually



You can manually select to scan digital channels. The channel numbers are determined by the broadcasting stations.

*Please make sure the **Main Input** is set to **Digital TV** using **TV/AV** button. Digital channels can be scanned only in **Digital TV** input mode.*

- 1 Press the **MENU** button.
- 2 Select **Channel** using the ▲/▼ button and press the **OK** or ► button.
- 3 Select **Manual Programme** using the ▲/▼ button and press the **OK** or ► button.
Selected **Channel** is highlighted.
- 4 Select the channel number that you want to scan using the ◀/▶ button.
- 5 Select **Search** using the ▲/▼ button and press the **OK** or ► button to start the search.
When completed, the number of scanned channel will be displayed for a while. And the first scanned channel, if only, will be automatically displayed.

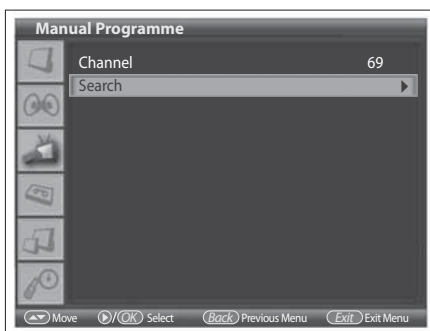

Editing Programmes



After channel scanning completes, you can delete, move, and skip saved channels or add them to the favourite channel list.

*Analog channels are editable only in **Analog TV** input mode and digital channels are editable only in **Digital TV** input mode.*

- 1 Press the **MENU** button.
- 2 Select **Channel** using the ▲/▼ button and press the **OK** or ► button.
- 3 Select **Edit Programmes** using the ▲/▼ button and press the **OK** or ► button. The **Edit Programmes** menu will appear.

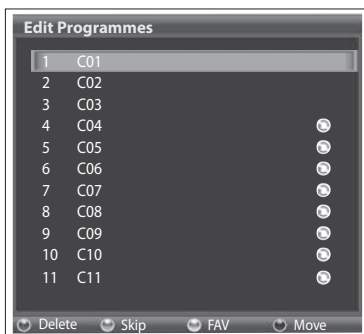

Note: **Move** is available for analog channels only.



Deleting Programmes (for analog/digital channels)

You can delete channels from the list.

- 1 Select a channel you want to delete using the ▲/▼ button and press the **RED** button. The selected channel is deleted.

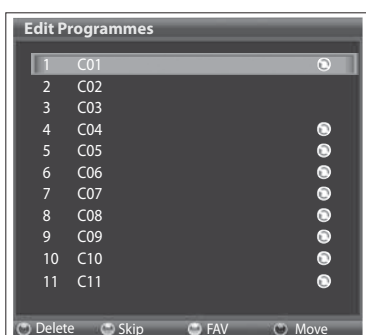

Skipping channels (for analog/digital channels)

Once channels are selected to skip, you can select the skipped channels using **NUMBER (0~9)** buttons only. The **P+/-** buttons will not function for the skipped channels.

- 1 Select a channel to skip using the ▲/▼ button and press the **GREEN** button. You can select multiple channels. (⊘) mark appears next to the channel name.

To clear the skipped channels, select the channel you don't want to skip and press the **GREEN** button.

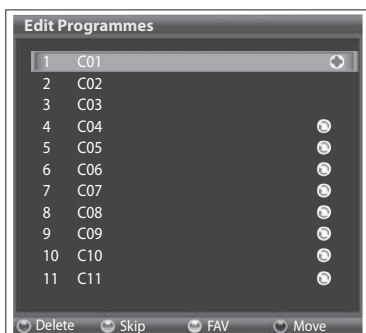

Adding Favourite Channels (for analog/digital channels)

You can add favourite channels or remove favourite channels from the list.

- 1 Select a channel to add into a favourite channel using the ▲/▼ button and press the **YELLOW** button. (⊕) mark appears next to the channel name.

To clear the favourite channels from the list, select the favourite channel you want to delete and press the **YELLOW** button.

If you press the **FAV** button, each favourite channel can be selected in sequent order.



Moving the Location of Programmes (for analog channels only)

You can change the location of channels in the channel list of **Edit Programme** menu.

- 1 Select a channel to move the channel location using the ▲/▼ button and press the **BLUE** button. (↻) mark appears next to the channel name.

- 2 Move the selection to a new location in the channel list using the ▲/▼ button, and press the **BLUE** button. The selected channel is moved to its new location and all other channels are shifted accordingly.

Viewing Channel List



You can view the list of all analog and digital channels using **LIST** button and switch to other channels on the channel list.

*Analog channel list appears only in **Analog TV** input mode and digital channel list appears only in **Digital TV** input mode.*

- 1 Press the **LIST** button while watching the analog or digital channels.
- 2 To change the channel, select your desired channel using the **▲/▼** button and press the **OK** button. The selected channel is displayed.

Note : You can move to your desired channel directly by entering the channel number using the **NUMBER (0~9)** buttons.

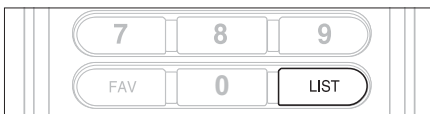

Displaying Information

You can display the channel information and setting status you selected on the screen.

Press the **OK** button to display the setting status of current screen in any input sources.

The current setting information such as the time, input source, aspect ratio, picture mode, sound effect and sleep timer is displayed at the top right hand corner of the screen.

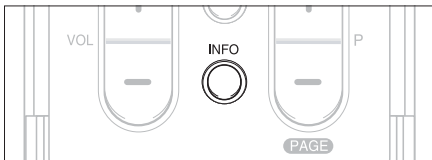
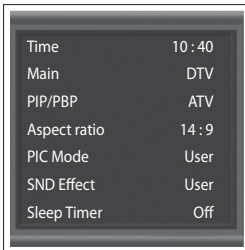

You can view the programme information by pressing the **INFO** button while watching a digital programme.

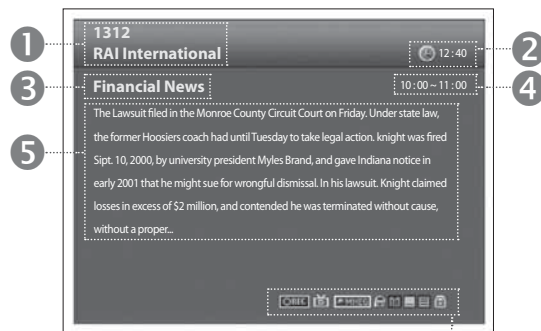

▲ Digital TV Input

- 1 Channel number and channel name
- 2 Current time
- 3 Programme name
- 4 Programme broadcasting time
- 5 Detailed programme information
- 6 Icons

	Displayed only when this channel is recording.
	Displayed when the channel supports data channel.
	Displayed when the channel supports teletext (MHEG).
	Displayed only if this programme is reserved.
	Represents the recommended minimum age for the current programme.
	Displayed only when the channel is a locked channel.
	Displayed only when the channel is a scrambled channel.
	Displayed only when subtitle information is available.
	Displayed only when there is any teletext information.

Displaying Digital Teletext (MHEG) (for the digital channels only)

If your chosen channel has teletext (MHEG) features, you can access them. Teletext services often load automatically shortly after the Digital Teletext window is displayed. In which case, simply follow the given instructions (press colour buttons).

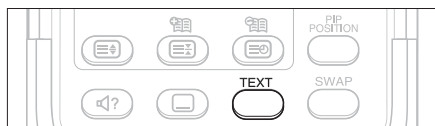

- 1 Press **TEXT** button to access teletext(MHEG) features.
- 2 Press **TEXT** button again to return to normal viewing.
- 3 Press the **P+/-** button to exit this service.

Note: You should select **Off** from the subtitle language to display teletext(MHEG).

Changing Subtitle Language (for the digital channels only)

If the current programme provides Subtitle information, you can select the language for the Subtitle.

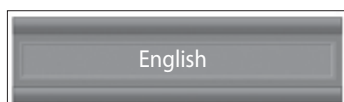

- 1 Press the **SUBTITLE** button to display the subtitle language list.
- 2 Select your desired subtitle language by pressing the **SUBTITLE** button repeatedly. Then the subtitle will be displayed in the selected language at the bottom of the screen.
- 3 Select **Off** from the subtitle language list if you do not wish to display subtitles in the screen.

Changing Audio Options



If the current programme is available in multiple audio languages, you can select the language that you wish to listen in.

▼ Analog



▼ Digital



- 1 Press the **SOUNDTRACK** button to display soundtrack list.
- 2 While watching the analog channels, select **Stereo** or **Mono** using the **▲/▼** button.
- 3 While watching the digital channels, select your desired audio language using the **▲/▼** button and select Audio preference (LL, LR, RR) using the **◀/▶** button.

The Electronic Programme Guide (EPG) displays the programme information including channel numbers, program titles, broadcasting schedules, and such. This service depends on the service provider. You can also schedule to record programmes using EPG information.

Electronic Programme Guide (EPG) is available only for digital channels.

Note: Press the **EPG** or **EXIT** button to exit the EPG screen.

Viewing the Electronic Programme Guide (EPG)

You can view programme information for all digital channels.

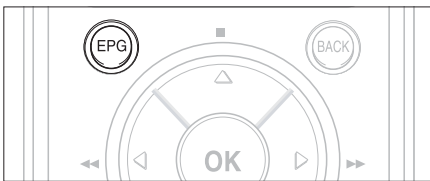

- 1 Press the **EPG** button while watching a TV programme. The Electronic Programme Guide (EPG) appears.

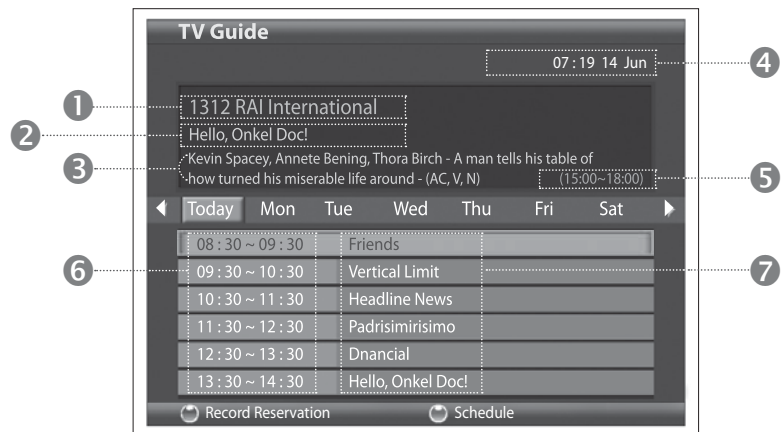

- 1 Channel number and channel name
 - 2 Name of selected programme
 - 3 Brief description of selected programme
 - 4 Current date and time
 - 5 Broadcasting time of selected programme
 - 6 Broadcasting time list
 - 7 Programme name list
- 2 Select a programme you want to see for further more information.
 - Use the ▲/▼ buttons to select a programme by broadcasting time.
 - Use the ◀/▶ buttons to select a programme by date within the same channel.
 - 3 If you press the **OK** or **INFO** button, you can view the detailed information of the selected event. Small icons at the bottom of the window show all the available functions for the selected channel. For detailed information about the detailed information, see **Chapter 3. Turning on Your TV > Displaying Information**.
 - 4 Press **EXIT** button to return to Live TV or press the **BACK** button to return to the previous menu.

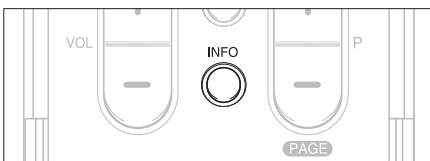

Note: EPG displays programme information for the next 7 days.

Reserving a Recoding



You can start or reserve a recording of the programme in the Electronic Programme Guide (EPG).

1 Press the **EPG** button.



2 To record a current broadcasting programme, select the current programme and press the **RED** button. The recording is started.

3 To reserve the recording of a future programme, select the desired programme and press the **RED** button. "This programme is reserved for recording" message appears.

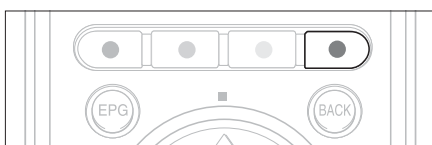

4 Press the **BLUE** button to move to the **Schedule** screen. The schedule screen displays the reserved programme list and lets you add, edit or delete the reservations. For detailed information about the scheduled recording, see **Chapter 9. Recording > Scheduled Recording**.

5 By the reserved time, the recording will be started.

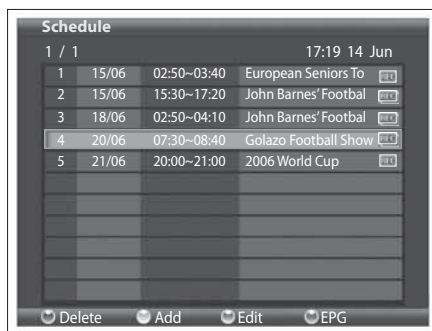

Note: By the reserved time during standby mode, the LCD panel goes out, but the recording will be started. The standby indicator on the front of your TV will turn on red.

Selecting a Picture Mode

You can select the picture mode which best fits your viewing requirements.

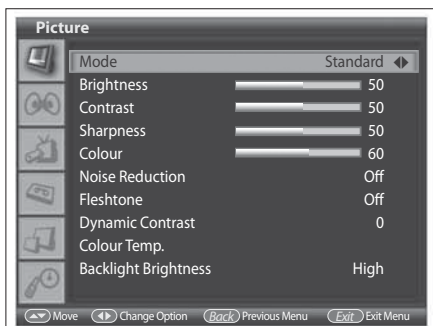

- 1 Press the **MENU** button.
- 2 Select **Picture** using the ▲/▼ button and press the **OK** or ► button.
- 3 Select the required picture mode using the ◀/▶ button.

The following options are available:

- **Standard**
Shows the optimal sharpness of the picture if viewed in a well-lighted room.
- **Dynamic**
Increases the clarity and sharpness of the picture.
- **Movie**
Select **Movie** to lessen eye strain when watching a movie in a dark place.
- **Mild**
Softens display with moderate sharpness of the picture.
- **Game**
Choose **Game** when you start a video game.
- **User**
Select **User** to set detailed options such as Brightness, Contrast, and Colour so on.



Note: You can select a picture mode by simply pressing the **PIC MODE** button on the remote control. Press again to switch.

- 4 Press the **EXIT** button to return to Live TV or press the **BACK** button to return to the previous menu.

Customizing the Picture Settings

You can adjust the picture appearance to suit your preference and viewing situations.

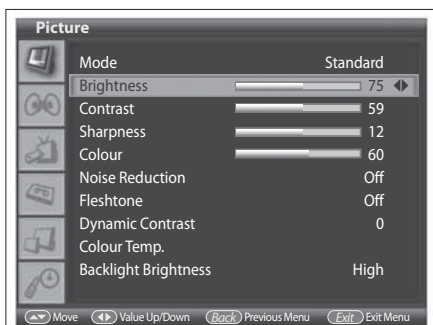

- 1 Press the **MENU** button.
- 2 Select **Picture** using the ▲/▼ button and press the **OK** or ► button.
- 3 Select the required option using the ▲/▼ button and press the ◀/▶ button.

The horizontal bar is displayed when selected to change.

The following options are available:

Brightness > Contrast > Sharpness > Colour

- **Brightness**
Adjusts the brightness of display.
- **Contrast**
Adjusts the contrast of display.
- **Sharpness**
Adjusts the sharpness of display.
- **Colour**
Adjusts colours of display.

- 4 Press the ◀/▶ button until you reach the optimal setting.
To select other options, repeat the steps from 3 to 4.
- 5 Press **EXIT** button to return to Live TV or press the **BACK** button to return to the previous menu.

Note: If you make any changes to the options, the picture mode is automatically switched to **User**. The **Colour** menu is not available in the PC input mode.

Noise Reduction

If the signal received by your television is weak, you can activate this feature to help reduce noise that may appear on the screen.

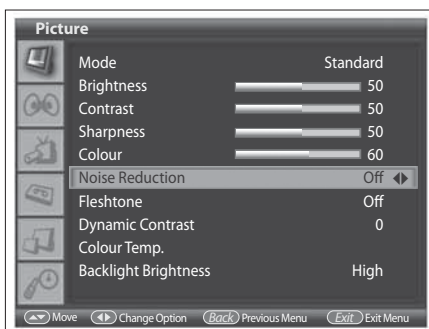

- 1 Press the **MENU** button.
- 2 Select **Picture** using the ▲/▼ button and press the **OK** or ▶ button.
- 3 Select **Noise Reduction** using the ▲/▼ button.
- 4 Select the required option by pressing the ◀/▶ button.
The following options are available.
Off > Adaptive > Low > Medium > High
- 5 Press the **EXIT** button to return to Live TV or press the **BACK** button to return to the previous menu.

Fleshtone

Use Fleshtone function to improve the picture quality by adjusting colour balance.

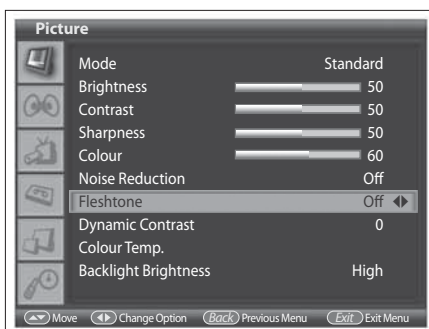

- 1 Press the **MENU** button.
- 2 Select **Picture** using the ▲/▼ button and press the **OK** or ▶ button.
- 3 Select **Fleshtone** using the ▲/▼ button.
- 4 Select the required option using the ◀/▶ button.
The following options are available:
Off > Low > Medium > High
- 5 Press the **EXIT** button to return to Live TV or press the **BACK** button to return to the previous menu.

Dynamic Contrast

Dynamic Contrast automatically detects the visual signal and adjusts to create optimal contrast.

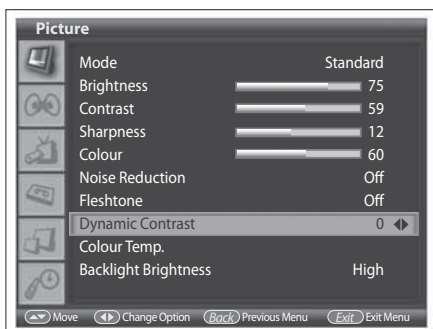

- 1 Press the **MENU** button.
- 2 Select **Picture** using the ▲/▼ button and press the **OK** or ► button.
- 3 Select **Dynamic Contrast** using the ▲/▼ button.
- 4 Change the contrast pressing the ◀/▶ button.
- 5 Press the **EXIT** button to return to Live TV or press the **BACK** button to return to the previous menu.

Colour Temperature

You can change the colour of the entire screen to fit your needs. Set to **Warm** for intensifying hot colours such as red, or set to **Cool** for displaying less intense colours with more blue.

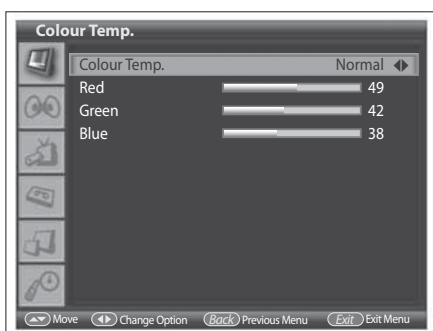

- 1 Press the **MENU** button.
- 2 Select **Picture** using the ▲/▼ button and press the **OK** or ► button.
- 3 Select **Colour Temp.** using the ▲/▼ button and press the **OK** or ► button.
- 4 Select the required colour temperature using the ◀/▶ button.
The following options are available:
User > Warm > Normal > Cool
- 5 To customise the colour temperature, select the required option using the ▲/▼ button.

The following options are available to make changes:

Red > Green > Blue

- 6 Press the ◀/▶ button until you reach the optimal setting. To select other options, press the ▲/▼ button.

Note: If you make any changes to the options, the colour temperature mode is automatically switched to **User**.

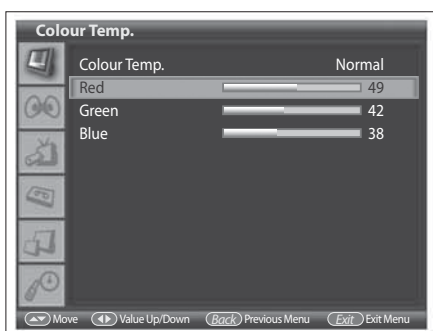

- 7 Press the **EXIT** button to return to Live TV or press the **BACK** button to return to the previous menu.

Adjusting Backlight Brightness

You can adjust the brightness of Liquid Crystal Display (LCD).

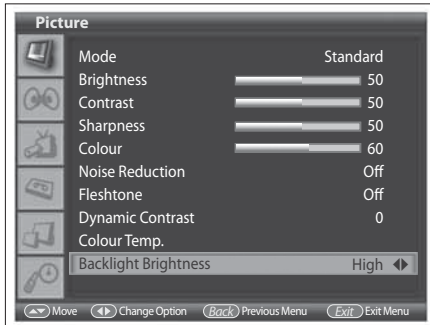

- 1 Press the **MENU** button.
- 2 Select **Picture** using the ▲/▼ button and press the **OK** or ► button.
- 3 Select **Backlight Brightness** using the ▲/▼ button.
- 4 Select the required option using the ◀/▶ button.
The following options are available:
Low > Medium > High
- 5 Press the **EXIT** button to return to Live TV or press the **BACK** button to return to the previous menu.

Setting the Sound Effect

You can select the type of special sound effect when watching a broadcasting programme.

Sound Effect lets you enjoy the best sound without any special adjustment because the TV sets the appropriate sound options based on the programme content.

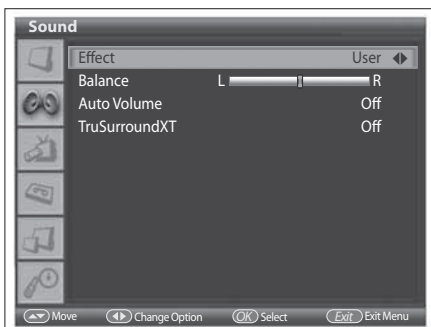

- 1 Press the **MENU** button.
- 2 Select **Sound** using the ▲/▼ button and press the **OK** or ► button.
- 3 Select the required sound effect using the ◀/▶ button.
The following options are available:

- **User**
Customise your own sound effect by changing equalizer settings after pressing the **OK** button.
- **Flat**
Flat and pure sound.
- **Speech**
Emphasises clear dialogue.
- **Movie**
Emphasises bass tones.
- **Music**
Enhances music quality.

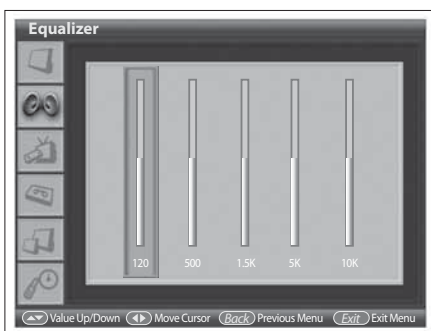

- 4 Press the **EXIT** button to return to Live TV or press the **BACK** button to return to the previous menu.

Note: You can select sound effect by simply pressing the **SND EFFECT** button on the remote control. Press again to switch.



Adjusting the Sound Balance

You can adjust the output of the right and left speakers to obtain the best stereo reproduction for your listening position.

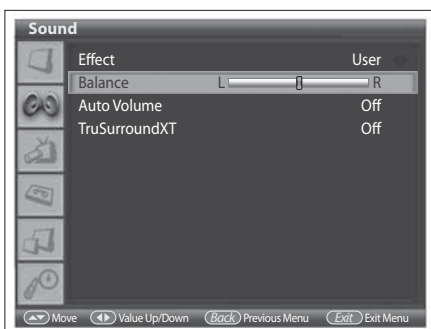

- 1 Press the **MENU** button.
- 2 Select **Sound** using the ▲/▼ button and press the **OK** or ► button.
- 3 Select **Balance** using the ▲/▼ button.
- 4 Press the ◀/▶ button to make changes.
- 5 Press the **EXIT** button to return to Live TV or press the **BACK** button to return to the previous menu.

Adjusting the Volume Automatically

Each broadcasting station has its own signal conditions, volume may not be adjusted each time you switch channels. This feature lets you automatically adjust the volume of the selected channel by adjusting the sound output depending on the signal modulation.

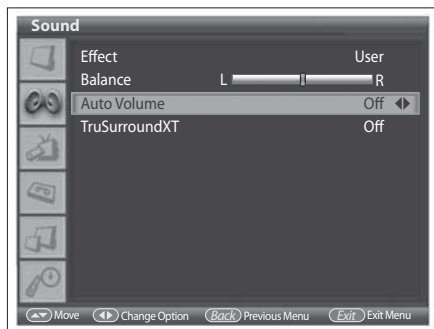

- 1 Press the **MENU** button.
- 2 Select **Sound** using the ▲/▼ button and press the **OK** or ► button.
- 3 Select **Auto Volume** using the ▲/▼ button.
- 4 Select **On/Off** using the ◀/▶ button.
- 5 Press the **EXIT** button to return to Live TV or press the **BACK** button to return to the previous menu.

Setting the TruSurround XT

TruSurround XT is a patented SRS technology that solves the problem of playing 5.1 multi-channel content over two speakers. TruSurround delivers a compelling, virtual surround sound effect through two-speaker playback system, including built-in television speakers. It is fully compatible with all multi-channel audio formats.

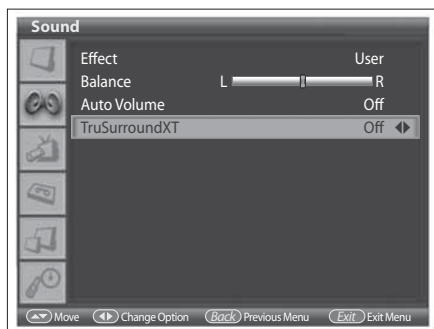

- 1 Press the **MENU** button.
- 2 Select **Sound** using the ▲/▼ button and press the **OK** or ► button.
- 3 Select **TruSurroundXT** using the ▲/▼ button.
- 4 Select **On/Off** using the ◀/▶ button.
- 5 Press the **EXIT** button to return to Live TV or press the **BACK** button to return to the previous menu.

Note: (SRS) is a trademark of SRS Labs, Inc. TruSurround XT technology is incorporated under license from SRS Labs, Inc.

Setting up Audio Priority (for the digital channels only)

You can fully enjoy sound effect with the optical output connected to an external digital audio decoder.

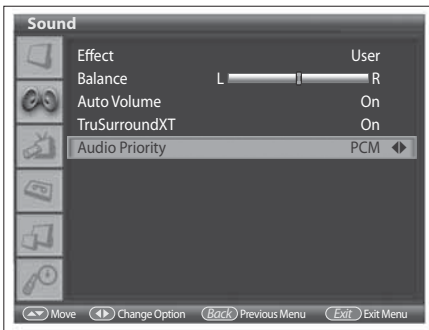

- 1 Press the **MENU** button.
- 2 Select **Sound** using the **▲/▼** button and press the **OK** or **▶** button.
- 3 Select **Audio Priority** using the **▲/▼** button.
- 4 Select either **PCM** or **Dolby Digital** by pressing the **◀/▶** button.
- 5 Press the **EXIT** button to return to Live TV or press the **BACK** button to return to the previous menu.

PIP/PBP/POP Settings

Also called **PIP(Picture-in-Picture)/PBP(Picture-by-Picture)/POP(Picture-out-of-Picture) function** allows you to watch two pictures with main and sub screens at the same time using your TV or other external devices.

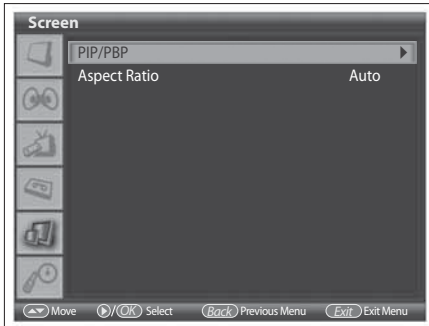

- 1 Press the **MENU** button.
- 2 Select **Screen** using the ▲/▼ button and press the **OK** or ► button. **PIP/PBP** is highlighted.
- 3 Press the **OK** or ► button again. The **Main Input** is selected. Press the ◀/▶ button to make changes.

Watching PIP/PBP/POP

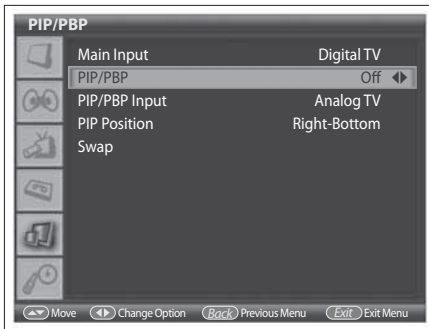

- 4 Select **PIP/PBP** using the ▲/▼ button.
- 5 Select the required PIP/PBP types by pressing the ◀/▶ button.
Off > PIP Small > PIP Large > PBP1 > PBP2 > POP

Notes:

1. You can select the PIP/PBP/POP modes by simply pressing the **PIP/PBP** button on the remote control. Press again to switch.
2. You can not change the aspect ratio when PIP/PBP/POP mode.
3. The PIP/PBP/POP function does not be worked with the PVR function at the same time. That is, the PIP/PBP/POP function is not available during playing, recording or time shifted state.



If you set PIP/PBP to Off, the followings are not available:

Selecting an Input Signal Source for PIP/PBP Function.

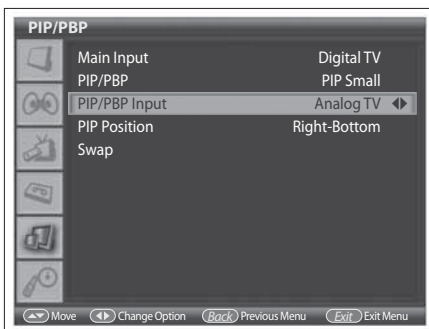

- 6 Select **PIP/PBP Input** using the ▲/▼ button.
- 7 Select the required input signal source by pressing the ◀/▶ button.
Digital TV > Analog TV > AV1 > AV2 > AV3(CVBS) > S-Video > Component > PC > HDMI.

Main Picture Source	Available Sub Picture Source
Digital TV	All input sources
Analog TV	Digital TV, Component, PC and HDMI
AV1, AV2, AV3(CVBS), S-Video	Digital TV only
Component, PC, HDMI	Digital TV and Analog TV

Note: You can select the input signal sources by simply pressing the **PIP INPUT** button on the remote control. Press again to switch.

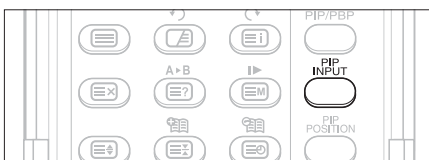

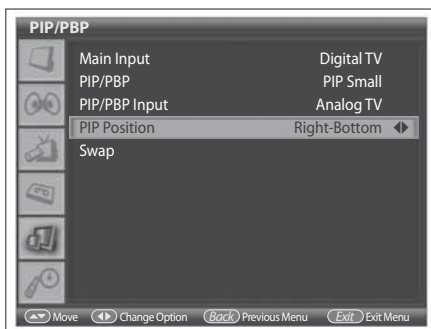

Changing the PIP Position

- 8 Select **PIP Position** using the ▲/▼ button.
- 9 Select the required position by pressing the ◀/▶ button.
Right-Bottom > Left-Bottom > Left-Top > Right-Top

Note: You can select the positions by simply pressing the **PIP POSITION** button on the remote control. It is available in the **PIP** mode only.

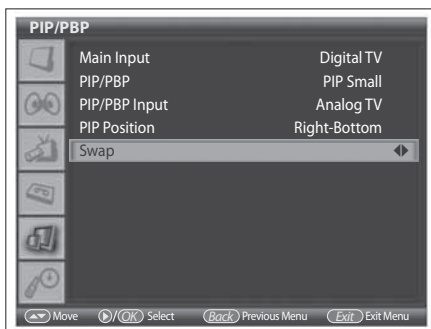
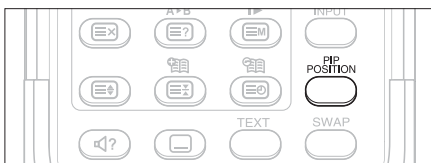

Swapping the Main and Sub Pictures

- 10 Select **Swap** using the ▲/▼ button.
- 11 Press the ▶ button to interchange the main picture and the sub-picture.

Note: You can interchange the pictures by simply pressing the **SWAP** button on the remote control.



SCART output in PIP/PBP/POP mode:

- When both the main and sub pictures are digital TV input, AV1(SCART1) outputs digital TV, not analog TV.
- When the main picture is digital TV input and the sub picture is RGB input from AV1 or AV2, AV1(SCART1) outputs nothing.

Note: Basically, on your TV, AV1(SCART1) outputs only Analog TV input signal and AV2(SCART2) outputs Digital TV, Analog TV, AV1, AV2, AV3 or S-Video input signal.

Setting the Aspect Ratio



You can change the aspect ratio of the screen which best corresponds to your viewing requirements.

- 1 Press the **MENU** button.
- 2 Select **Screen** using the ▲/▼ button and press the **OK** or ► button.
- 3 Select **Aspect Ratio** using the ▲/▼ button.
- 4 Select the aspect ratio of your choice by pressing the ◀/▶ button.
Auto > 4:3 > 14:9 > 16:9 > Zoom1 > Zoom2



Notes:

1. You can select the modes by simply pressing the **WIDE** button on the remote control.
2. When the PC input mode, you can select only the 4:3 or 16:9.

Auto

Displays the picture as the original aspect ratio of the signal you received.

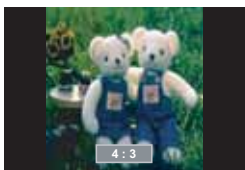

4:3

Displays the picture in the 4:3 ratio. The black bar appears on each side.



14:9

Displays the picture in the 14:9 ratio. The thin black bar appears on each side.



16:9

Displays the picture in the 16:9 ratio to fill the entire screen.

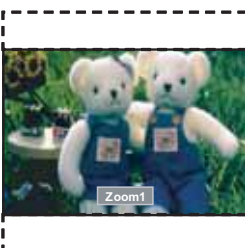

Zoom1

Displays the picture zoomed to fill the 16:9 ratio in a full screen display. The top and bottom of the picture are cropped.

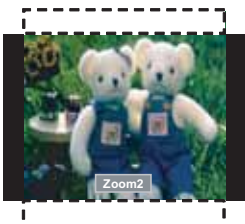

Zoom2

Displays the picture zoomed to fill the 14:9 ratio with black sidebars. The top and bottom of the picture are slightly cropped.

Setting the Current Time Information

You can set the current time. If you want to set time for automatically turning on/off the power, you must set the local time first.

Setting the Current Date and Time

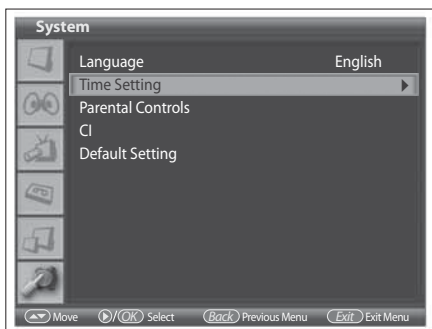

- 1 Press the **MENU** button.
- 2 Select **System** using the ▲/▼ button and press the **OK** or ► button.
- 3 Select **Time Setting** using the ▲/▼ button and press the **OK** or ► button.
- 4 Select **Date** using the ▲/▼ button and press the **OK** or ► button.
- 5 Press the ◀/▶ button to select day, month or year, and then adjust them pressing the ▲/▼ or **NUMBER (0~9)** buttons.
- 6 When you are finished, press the **OK** button to save the date.
- 7 Select **Local Time** using the ▲/▼ button and press the **OK** or ► button.
- 8 Press the ◀/▶ button to select hour/minute and then set the current time pressing the ▲/▼ or **NUMBER (0~9)** buttons.
- 9 When you are finished, press the **OK** button to save the local time.

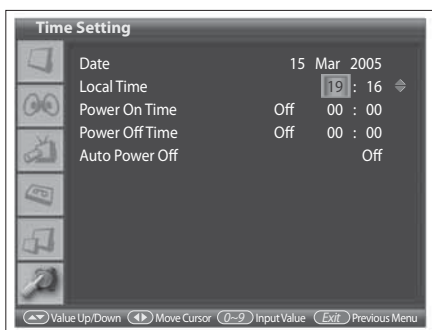

Note: Your TV automatically sets and updates the time over the air when you successfully search digital terrestrial channels.

Using the TV Timer Function

You can schedule time for automatically turning on/off the power so that your TV will automatically be turned on and off at specific time you have scheduled.

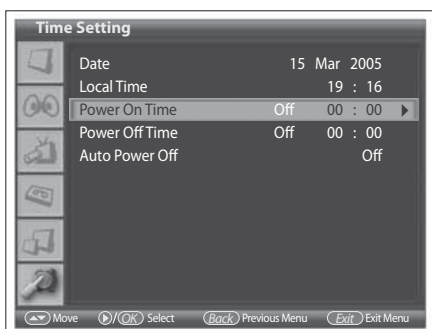

- 1 Press the **MENU** button.
- 2 Select **System** using the ▲/▼ button and press the **OK** or ► button.
- 3 Select **Time Setting** using the ▲/▼ button and press the **OK** or ► button.
- 4 To set time for turning on the power, select **Power On Time** using the ▲/▼ button and press the ◀/▶ button to select **On**.
- 5 **Power On Time** is enabled, press the ◀/▶ button to select hour/minute, and then set time pressing the ▲/▼ or **NUMBER (0~9)** buttons.

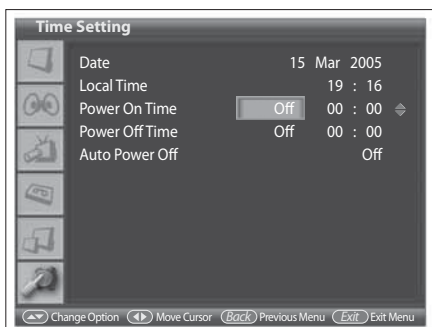

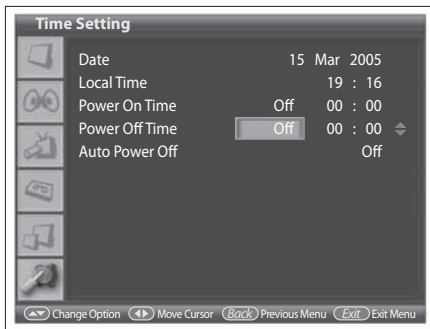

- 6 When you are finished, press the **OK** button to save the time for turning on the power.
- 7 To set time for turning off the power, select **Power Off Time** using the **▲/▼** button and press the **◀/▶** button to select **On**.
- 8 **Power Off Time** is enabled, press the **◀/▶** button to select hour/minute, and then set time pressing the **▲/▼** or **NUMBER (0~9)** buttons.
- 9 When you are finished, press the **OK** button to save the time for turning off the power.

Setting the Auto Power Off

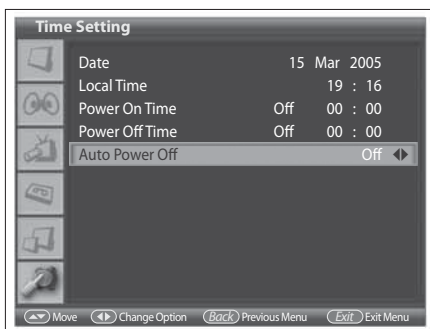

In case there is no signal, it is possible have your TV automatically turned off to reduce power consumption.

- 1 Press the **MENU** button.
- 2 Select **System** using the **▲/▼** button and press the **OK** or **▶** button.
- 3 Select **Time Setting** using the **▲/▼** button and press the **OK** or **▶** button.
- 4 Select **Auto Power Off** using the **▲/▼** button and press the **◀/▶** button to select **On**. The TV will automatically be turned off if there is no signal for 15 minutes.

Parental Control (for the digital channels only)

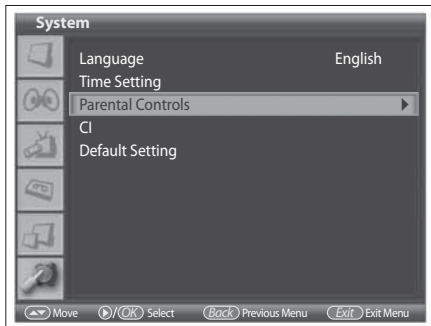

This feature enables you to prevent unauthorised users such as children from watching adult channels or programmes by using a password you have defined.

- 1 Press the **MENU** button.
- 2 Select **System** using the ▲/▼ button and press the **OK** or ► button.
- 3 Select **Parental Controls** using the ▲/▼ button and press the **OK** or ► button.
The **Please enter password** dialog box is displayed.
- 4 Enter your password by pressing the **NUMBER (0~9)** buttons. The **Age limit** menu is selected.

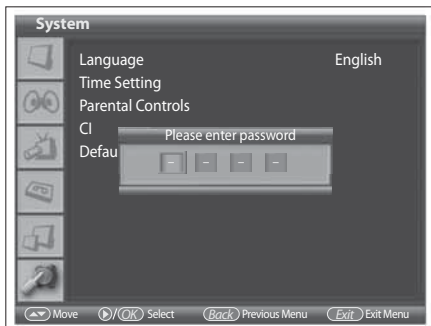

Setting the Age Limit

Age Limit enables you to block programmes from unauthorised users according to the age level you have defined.

- 1 Select the **Age limit** using the ▲/▼ button.
- 2 Define ages for unauthorised users not to access to blocked programmes using the ◀/▶ button.

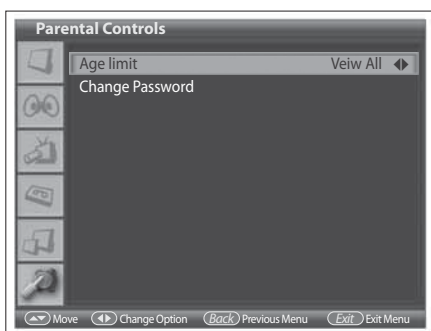

View All : All programmes are not blocked.

7 : Programmes is blocked for age groups under 7.

12 : Programmes is blocked for age groups under 12.

15 : Programmes is blocked for age groups under 15.

18 : Programmes is blocked for age groups under 18.

Lock All : All Programmes are blocked without considering the age level.

Notes:

1. If you select a blocked channel "This programme is blocked by age" message appears.
2. To watch the blocked programmes by the age restriction, you have to set the **Age limit** to **View All** in the **Parental Controls** menu.

Changing the Password

You can change the current password to a new one.

- 1 Select **Change Password** using the ▲/▼ button and press the **OK** or ► button.
- 2 Enter your new password using the **NUMBER (0~9)** buttons.
- 3 Enter the new password again to confirm. Then your new password has been memorized.

Note: The Default Password is "0000". If you have forgotten your password, please contact your local TV distributor.



Common Interface (for the digital channels only)

You can view the current status of the CI module. The **CI** sub menu displays when inserting the CI module or Smartcard to the TV.

- 1 Press the **MENU** button
- 2 Select **System** using the ▲/▼ button and press the **OK** or ► button.
- 3 Select **CI(Common Interface)** using the ▲/▼ button and press the **OK** or ► button.
- 4 If Common Interface is available, you can view information about each Slot.

Note: The displayed information about each Common Interface may differ depending on the type of Common Interface.

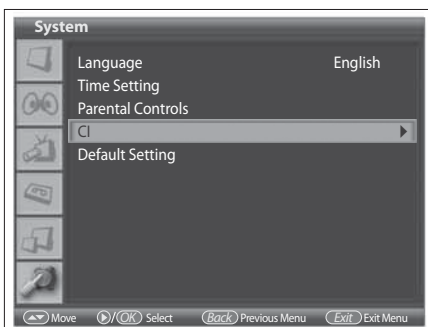

Default Settings

You can set your TV settings to the default setting values.

Warning: Please note that once you perform the Default Setting, all data such as aerial setting information, channel list, and user configured data are deleted.

To perform Default Setting, do as follows:

- 1 Press the **MENU** button.
- 2 Select **System** using the **▲/▼** button and press the **OK** or **▶** button.
- 3 Select **Default Setting** using the **▲/▼** button and press the **OK** or **▶** button. The **Please enter password** dialog box is displayed.
- 4 Enter your password using the **NUMBER (0~9)** buttons.
- 5 Select **Yes** using the **◀/▶** button and press the **OK** button to change all settings value to the factory default. Select **No** using the **◀/▶** button and press the **OK** button or press the **BACK** button to return to the previous menu.
- 6 Default setting is complete. Then, the TV is automatically turned off and on.

Note: The default password is "0000". If you have forgotten your password, please contact your local TV distributor.

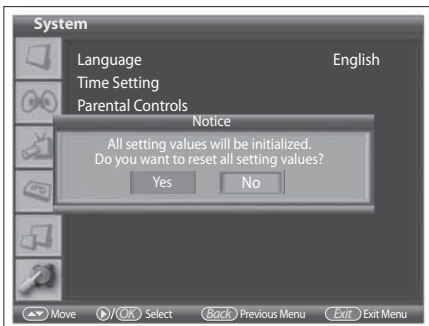
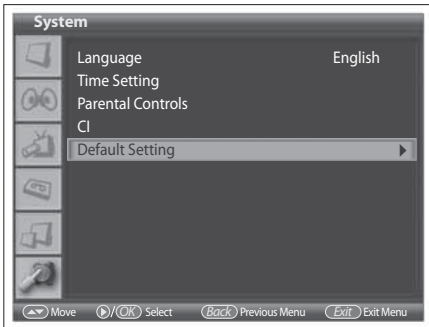

This chapter describes the PVR (Personal Video Recorder) function that allows you to record a programme in the installed hard disk drive.

Setting the Recording Quality



- 1 Press the **MENU** button.
- 2 Select **Recording** using the **▲/▼** button, and press the **OK** or **▶** button.
- 3 Select **Recording Quality** using the **▲/▼** button and press the **◀/▶** button to select one of three recording quality.

Recording Quality	Recording Time
HQ : High Quality	Approx. 36Hr.
SP : Standard Play	Approx. 64Hr.
LP : Long Play	Approx. 130Hr.

In general, the recording quality improves as the recording time decreases. Recording time may vary according to specific conditions.

Time-Shift Recording (TSR)

The TV automatically record the programme on air in the installed hard disk drive temporarily, so that users can pause, play, fast rewind, fast forward, instant replay, etc. even while watching the currently broadcasting TV programme.

Note: While instant recording or scheduled recording, you cannot perform the time shifted recording and playback.

TSR Time Bar

If you press playback control buttons while watching TV, the TSR Time bar appears on the bottom of the screen.

TSR Time bar displays the current operation status, the time of the watching point, and the amount of temporarily saved programme.

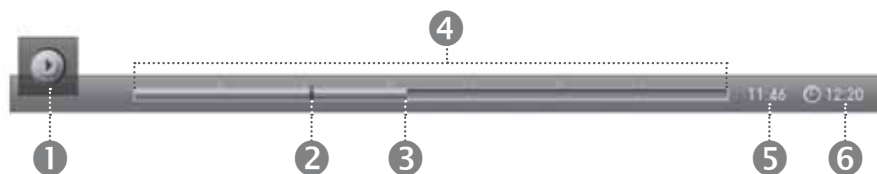

- 1 Operation status
- 2 Watching point
- 3 Broadcasting (Live) point
- 4 The amount of saved programme (max. 2 hours)
- 5 The time of watching point (hh:mm)
- 6 Current time (hh:mm)

Note: When the operation status is **PLAYING** (▶) or **LIVE** on the TSR Time bar, if you take no action for about 3 seconds, the TSR Time bar will be disappear.

Playback Control

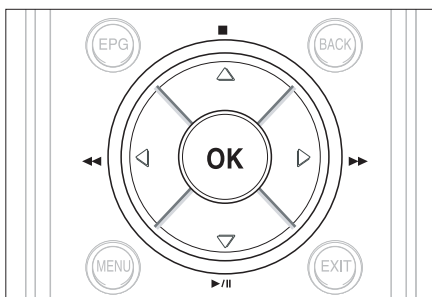
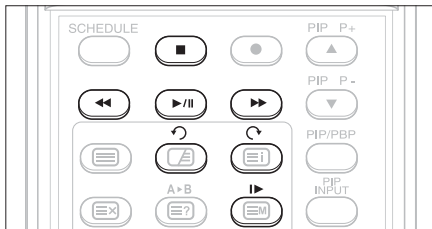

Play/Pause

Press the **PLAY/PAUSE** (▶/||) button to pause the playback. Press the button again to resume playback. TSR Time bar disappears after 10 seconds.

Note: Pause makes the time difference or delay between the broadcasting point and watching point. The time difference is equal to the paused time period. You can check the time difference in the TSR Time bar. Other operations such as slow motion and rewind also make the time difference. Press **STOP** (■) button to remove the time difference and watch the programme on air presently.

Stop

Press the **STOP** (■) button to stop TSR playback and watch the programme on air presently.

Fast Forward

Press the **FAST FORWARD** (▶▶) button to quickly advance a recorded file. Each time you press the **FAST FORWARD** (▶▶) button, the forward speed increases by 4 steps (x2, x4, x16, x64).

TSR Time bar is shown during the fast forwarding. If you press the **PLAY/PAUSE** (▶/||) button during the fast forwarding, the programme is played at normal speed.

Note: You can use the fast forward operation only when there is a time difference between the current watching and the broadcasting point caused by some previous operations such as pause, slow motion, or rewind. You can fast forward up to the current broadcasting point. If the watching point reaches to the broadcasting point, the programme will play at normal speed.



Fast Rewind

Press the **FAST REWIND** (◀◀) button to rewinds the programme fast. Each time you press the **FAST REWIND** (◀◀) button, the rewind speed increases by 4 steps (x2, x4, x16, x64).

TSR Time bar is shown during the fast rewinding. If you press the **PLAY/PAUSE** (▶/||) button during the fast rewinding, the programme is played at normal speed.

Note: You can rewind to the point when you have changed to the current channel. If the watching point reaches the start point during rewinding, the programme will begin to play at normal speed from the point.

Slow Motion

Press the **Slow Motion** () button to play the current programme in slow motion. Each time you press the **Slow Motion** () button, the slow speed decreases by 3 steps (x1/2, x1/4, x1/8).

TSR Time bar is shown during the slow motioning. If you press the **PLAY/PAUSE** () button during the slow motioning, the programme is played at normal speed.

Instant Replay

Press the **Instant Replay** () button to replay the current programme from the 15 seconds before. When the replay has been completed, the programme is normally played from the point.

Commercial Skip

Press the **Commercial Skip** () button to play the programme from the time point 15 seconds forward from the current watching point. You can use the skip operation only when there is a time difference between the current watching and the broadcasting point. If the time difference is less than 15 seconds, the programme is played from the current broadcasting point.

Note: **A-B Repeat** (), **Add Bookmark** () and **Bookmark Jump** () buttons do not work in the time shifted state.

Instant Recording

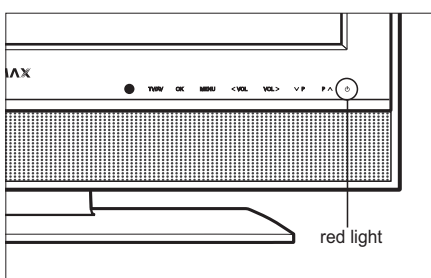
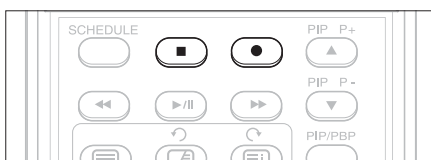
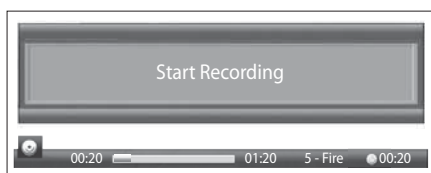

- 1 Press the **RECORD** (●) button on the remote control to record the current programme instantly.
- 2 You can change the recording end time by pressing the **RECORD** (●) button again. Each time you press the ◀ or ▶ button, the end time decreases or increases by 10 minutes.
- 3 Press the **STOP** (■) button to stop recording.

Notes:

1. You can't record the radio or data programmes.
2. Recording is not available from Component, HDMI or PC input sources.
3. During recording, you can playback the recorded programmes.
4. During recording, you can't record the different channel or AV input sources.
5. During recording, the TSR(Time Shifted Recording) is not available.
6. During Digital TV or Analog TV recording, you can't access to the **Channel** menu.
7. You can reset the recording time while recording.
8. You may not record scrambled programmes or data programmes normally.
9. You should stop recording to watch the scrambled programme.
10. During the Standby mode, the LCD panel goes out, but the recording is continued. The standby indicator on the front of your TV turns on **RED**.
11. Ensure that there is enough free space before recording, because if the free space on the hard disk drive is insufficient, recording will stop. Recording 1 hour of programme may require up to 2GB of free space of hard disk space. The space for recording 1 hour of programme may be different depending on the programme recorded.
12. The default recording time of instant recording is 1 hour.
13. During playback the recorded programmes, you can't record instantly.

Scheduled recording

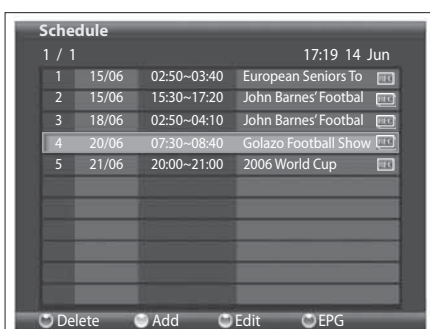

You can schedule to record the programmes on EPG information or scheduled recording.

For detailed information on recording using the EPG, refer to chapter 4.

You can view the Schedule list by selecting **Menu > Recording > Schedule** or pressing the **SCHEDULE** button.

- 1 Press the **SCHEDULE** button.
The **Schedule** appears.

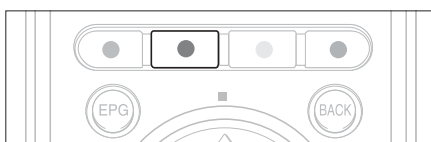
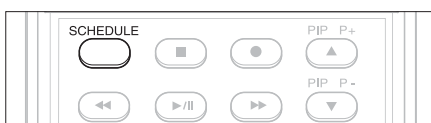

Adding a Reservation

- 2 Press the **GREEN** button to display the new reservation screen.
- 3 Select an input source you want to record using the ◀/▶ button.
- 4 Change the channel number, date and time using the ◀/▶ or **NUMBER** (0~9) buttons.
- 5 Change **Repeat** mode using the ◀/▶ button. The options are **Once** (REC), **Daily** (REC), **Weekly** (REC), **Weekday** (REC) and **Weekend** (REC).

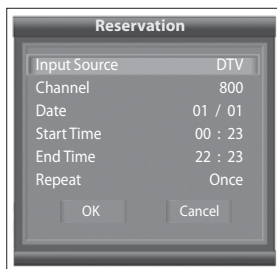

- 6 Select **OK** and press the **OK** button to add the new reservation.
- 7 Select **Cancel** and press the **OK** button to cancel the reservation.

Notes:

1. The recording schedule can't be overlapped with any other ones.
2. You can set the **Power On/Off Time** overlapping the recording schedule.

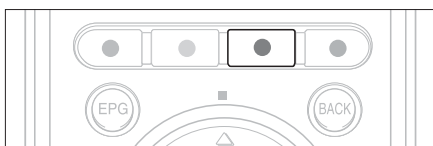

Editing a Reservation

- 2 Select the reserved programme and press the **YELLOW** button to display the reserved information.
- 3 Select an input source you want to record using the ◀/▶ button.
- 4 Change the channel number, date and time using the ◀/▶ or **NUMBER (0~9)** buttons.
- 5 Change **Repeat** mode using the ◀/▶ button. The options are **Once (REC)**, **Daily (REC)**, **Weekly (REC)**, **Weekday (REC)** and **Weekend (REC)**.
- 6 Select **OK** and press the **OK** button to save the changes.
- 7 Select **Cancel** and press the **OK** button to cancel the editing.

Deleting a Reservation

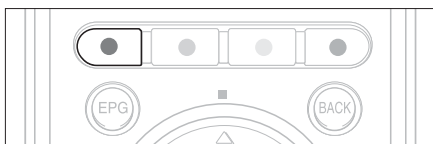

- 2 Select a reservation you want to delete and press the **RED** button. "Do you want to delete this schedule?" message appears.
- 3 Select **OK** and press the **OK** button to delete the reservation.
- 4 Select **Cancel** and press the **OK** button to cancel.

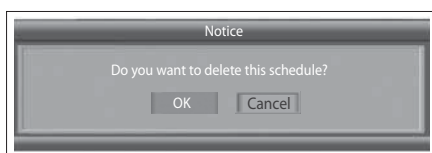

By the reserved time, the recording will be started with a confirm message.

Notes:

1. You can't record the radio or data programmes.
2. Recording is not available from Component, HDMI or PC input sources.
3. During recording, you can playback the recorded programmes.
4. During recording, you can't record the different channel or AV input sources.
5. During recording, the TSR(Time Shifted Recording) is not available.
6. During Digital TV or Analog TV recording, you can't access to the **Channel** menu.
7. You can reset the recording time while recording.
8. You may not record scrambled programmes or data programmes normally.
9. By the reserved time during standby mode, the LCD panel goes out, but the recording will be started. The standby indicator on the front of your TV will turn on **RED**.
10. Ensure that there is enough free space before recording, because if the free space on the hard disk drive is insufficient, recording will stop. Recording 1 hour of programme may require up to 2GB of free space of hard disk space. The space for recording 1 hour of programme may be different depending on the programme recorded.

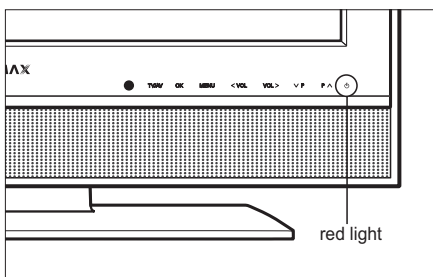

11. By the reserved time during playback the recorded programmes, the playback is stopped automatically and the recording is started.
12. If you delete the reserved channel by editing programmes (by mistake), when the reserved time comes, “**Scheduled recording fail**” message will appear.
13. Press the **BLUE** button to move to the **EPG (TV Guide)** screen.

Programme Playback

You can view the recorded programme list by selecting **Menu > Recording > Playlist** or pressing the **PLAYLIST** button. You can play your desired programmes in the list.

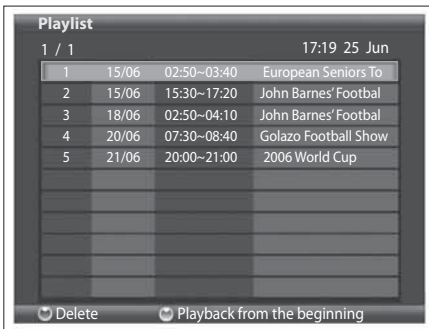

- 1 Press the **PLAYLIST** button.
The **Playlist** appears.
- 2 Select a desired programme using the **▲/▼** button and press the **OK** or **PLAY/PAUSE** (**▶/||**) button to play.
Time bar appears as shown below while playing the selected programme.

Note: In case of the digital programmes recorded less than 2 minutes, the programme name may be displayed inaccurately. Because the events can be changed while recording.

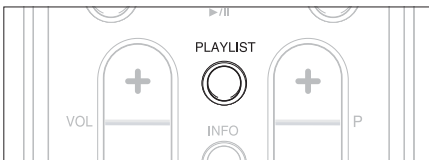

Time Bar

If you press playback control buttons while watching the recorded programme, the Time bar appears on the bottom of the screen.

Time bar displays the current playback status as follows:

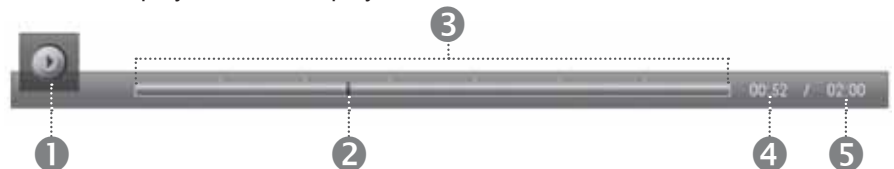

- 1 Operation status
- 2 Watching point
- 3 The amount of saved programme
- 4 Currently playing time (hh:mm)
- 5 The total playback time (hh:mm)

Note: When the operation status is **PLAYING** (**▶**) on the Time bar, if you take no action for about 3 seconds, the Time bar will be disappear.

Playback Control

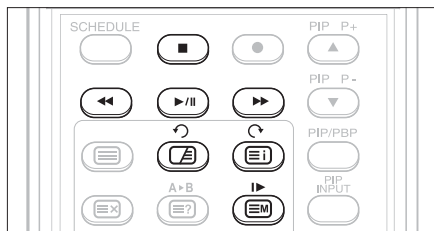

Play/Pause

Press the **PLAY/PAUSE** (▶/⏸) button to pause the playback. Press the button again to resume playback. Time bar disappears after 3 seconds.

Stop

Press the **STOP** (■) button to stop playback and returns to the previous screen.

Fast Forward

Press the **FAST FORWARD** (▶▶) button to quickly advance a recorded file. Each time you press the **FAST FORWARD** (▶▶) button, the forward speed increases by 4 steps (x2, x4, x16, x64).

Time bar is shown during the fast forwarding.

Once it reaches the end point of playback, it stops playing and returns the Playlist. If you press the **PLAY/PAUSE** (▶/⏸) button during the fast forwarding, the programme is played at normal speed.

Fast Rewind

Press the **FAST REWIND** (◀◀) button to rewinds the programme fast.

Each time you press the **FAST REWIND** (◀◀) button, the rewind speed increases by 4 steps (x2, x4, x16, x64).

Time bar is shown during the fast rewinding. Once it reaches the beginning point of playback, it starts playing.

If you press the **PLAY/PAUSE** (▶/⏸) button during the fast rewinding, the programme is played at normal speed.

Slow Motion

Press the **Slow Motion** (◄▶) button to play the current programme in slow motion. Each time you press the Slow Motion (◄▶) button, the slow speed decreases by 3 steps (x1/2, x1/4, x1/8).

TSR Time bar is shown during the slow motioning. If you press the **PLAY/PAUSE** (▶/⏸) button during the slow motioning, the programme is played at normal speed.

Instant Replay

Press the **Instant Replay** (↶) button to replay the current programme from the 15 seconds before. When the replay has been completed, the programme is normally played from the point.

Commercial Skip

Press the **Commercial Skip** (↷) button to play the programme from the time point 15 seconds forward from the current watching point.

Repeat between (A – B)

Plays special section repeatedly.

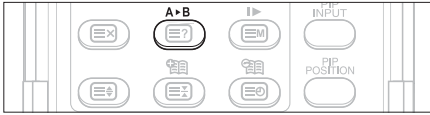

- 1 Press the **A-B Repeat (A▶B)** button at watching point where you want to start repeating from.
- 2 Press the **A-B Repeat (A▶B)** button again at the ending point to stop repeating. Selected watching points (A and B) start repeating. (▼) marks appear at the starting and ending points on the Time bar.
- 3 To return to normal playback, press the **A-B Repeat (A▶B)** button once again.

Using the Bookmark Function

You can set bookmarks where you want to save the specific scenes of recorded files for easier search.



Adding Bookmarks

Press the **Add Bookmark** (📌) button at the desired scene where you want to add a bookmark. **“Set Bookmark”** message appears.



Note: You can save 16 bookmarks for the maximum. If you try to save more than sixteen bookmarks, **“No more bookmark available”** message appears.

Using Bookmark Jump



Press the **Bookmark Jump** (📌) button. Bookmark icon (▲) appears on the Time bar and playback is started at the selected bookmark point automatically. Each time you press the **Bookmark Jump** (📌) button, bookmark icon is shifted to each bookmark.

Deleting Bookmarks

Select a bookmark you want to delete by pressing the **Bookmark Jump** (📌) button repeatedly and press the **Add Bookmark** (📌) button within 5 seconds. The selected bookmark is removed.

After the playback ends, bookmark lists are saved.

Checking Hard Disk Drive

You can check the free space of built-in hard disk and format the disk if necessary.



- 1 Press the **MENU** button.
- 2 Select **Recording** using the ▲/▼ button and press the **OK** or ► button.
- 3 Select **HDD Control** using the ▲/▼ button and press the **OK** or ► button.
- 4 You can check the free, used, reserved, and total space of the HDD.

If you want to format disk

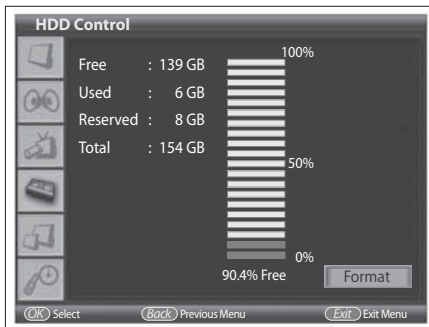

- 5 Press the **OK** button to remove all the recorded programmes saved on the built-in hard disk and initialize the hard disk.
- 6 Enter your password by pressing the **NUMBER (0~9)** buttons.
- 7 Select **Yes** for the format confirm message and press the **OK** button to start formatting the hard disk.

Notes:

1. Please notice that all the recorded programmes saved on the hard disk are deleted during the hard disk format. Don't unplug the power cord during the hard disk format. If you unplug the power cord, you should restart to format hard disk.
2. When completing the hard disk format, your TV automatically is rebooted and switched into the Digital TV input mode.

Displaying Teletext information

You can view teletext information at any time on your TV.

Most of TV broadcasting stations provide text information services via teletext. The index page of the teletext service gives you information on how to use the service. You can also select various options to fit your needs using the buttons on your remote control.

Note: To properly display teletext information, channel reception must be stable. Otherwise, information may be missing or some pages may not be displayed.

TELETEXT related buttons are as shown below:

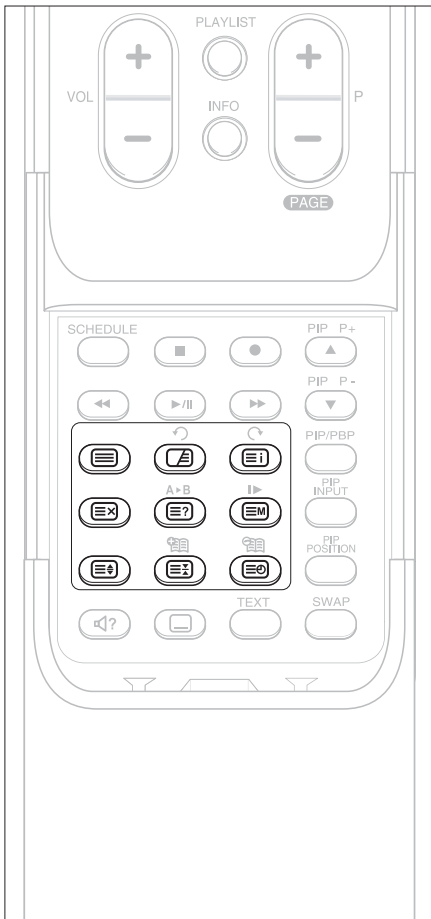

(Teletext On/Off)

Activates or deactivates the teletext service.

(Mix)

Overlaps the teletext with the broadcasting screen. Adjusts the opacity to the background in Teletext mode.

(Index)

Displays the teletext index page.

(Cancel)

Displays TV programmes when searching for the new teletext page.

(Reveal)

Shows the hidden information. (answers to quiz games, for example) Press it again to return to normal display.

(Mode)

Selects the teletext mode (LIST/FLOF)

(Size)

Displays the double-size letters for lower half of the screen, press it again to return to normal display.

(Hold)

Holds the display on a given page if the selected page is linked with several secondary pages that automatically follow. To resume, press it again.

(Time)

When watching TV programmes, press it to display the time at the top right hand corner of the screen.

Number (0~9)

Press to enter the three-digit page number given in the content.

Coloured buttons (Red/Green/Yellow/Blue)

If the FASTEXT system is used by a broadcasting company, the different topics covered on a teletext page are colour-coded and can be selected by pressing the coloured buttons. Press one of them according to your needs. The page is displayed with other coloured information that can be selected in the same way. To display the previous or next page, press the corresponding coloured button.

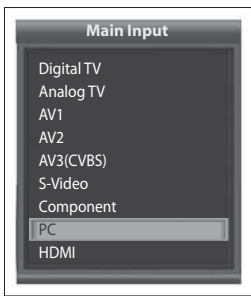

The **PC** menu shows in the PC input mode only.

- 1 Press the **TV/AV** button to switch to **PC** mode.
- 2 Select **PC** using the **▲/▼** button and press the **OK** button.



Auto Configure

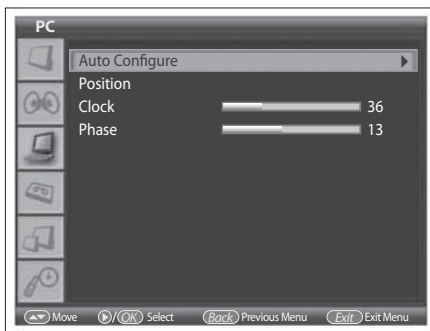

Automatically optimizes the display. This is recommended for the first time connecting to a PC.

- 3 Press the **MENU** button.
- 4 Select **PC** using the **▲/▼** button and press the **OK** or **▶** button.
- 5 Select **Auto Configure** using the **▲/▼** button and press the **OK** or **▶** button.

Position

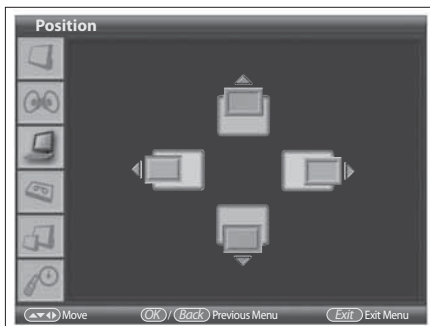

Adjusts the display position to PC if it does not fit the TV screen.

- 5 Select **Position** using the **▲/▼** button and press the **OK** or **▶** button.
- 6 Adjust the position using the **▲/▼/◀/▶** buttons and press the **OK** button.

Clock

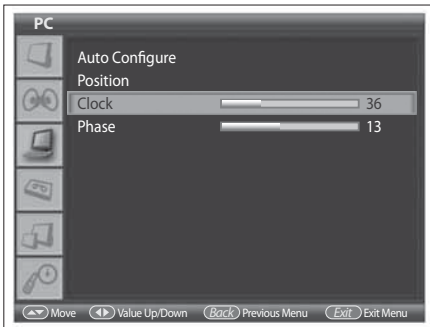

Adjusts the horizontal feature of screen by increasing or decreasing the number of pixels.

- 5 Select **Clock** using the ▲/▼ button and press the **OK** or ► button.
- 6 Adjust the optimal horizontal feature using the ◀/▶ button and press the **OK** button.

Phase

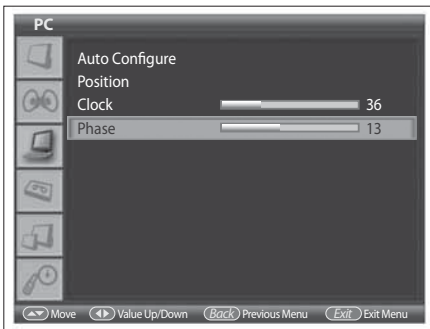

Sets the focus of screen.

- 5 Select **Phase** using the ▲/▼ button and press the **OK** or ► button.
- 6 Adjust the optimal focus using the ◀/▶ button.

Note: If noise is present, change the PC mode to another resolution, change the refresh rate to another rate until the picture is clear. If the refresh rate of the PC graphic card can not be changed, change the PC graphic card or consult the manufacturer of the PC graphic card.

In order to maintain proper performance of the TV, it is essential to have the most up-to-date software. The latest news and release of software versions may be found at the **HUMAX website** – <http://www.humaxdigital.com>. It is recommended that you periodically check for the availability of software update.

OTA (Over the Air)

OTA, an abbreviation of **Over-the-Air**, means that the software can be downloaded through your aerial. The manufacturer reserves the right to decide when and where to release software by this process. The software update via your aerial will only occur under the following circumstances.

- 1 The equipment should have appropriate loader software.

Caution: Please note that if you don't have normal loader software, the equipment may not be updated or work after software update.

- 2 The manufacturer decides to release software downloading via a designated aerial system.
- 3 The equipment must be **tuned** properly according to the guidelines within this manual.
- 4 Update software when the quality of receiving signal strength is high. If the weather is not so good that the quality of receiving signal strength is not recommendable, perform the software update later.

Caution:

- Please be careful to keep the power on and the power cord plugged in during software update. If the power is disconnected during software update, it may cause fatal damage to the TV.
- Please be careful not to pull out the signal line (co-axial Cable) during software update. Update may be interrupted and the TV may not work.

Notes:

1. The other functions of TV cannot work at all during software update.
 2. It may take 5 ~10 minutes to update software.
 3. Scheduling operation cannot work during software update.
-



If new software is found when powering on

- 1 A message will be displayed to notify that new software is found.
- 2 Select **Yes** and press the **OK** button to update the software.
- 3 Starts downloading new software. Please wait until the updated is completed.
- 4 When completing the software update, the equipment is automatically powered off and on again.



If updating software from Menu

- 1 Press the **MENU** button.
- 2 Select **Channel** using the **▲/▼** button and press the **OK** or **▶** button.
- 3 Select **Software Update** using the **▲/▼** button, and press the **OK** or **▶** button. The **Please enter password** dialog box is displayed.
- 4 Select the country where you are now located using the **◀/▶** button.

Note: **Software Update** appears only in **Digital TV** input mode.



Automatic Update

You can set the TV to find HUMAX software update site and update software automatically.

- 1 Select **Automatic Update** using the **▲/▼** button, and press the **OK** or **▶** button. Automatically search for new software.
- 2 When detecting update software, the following result is displayed. If new software is not found by **Automatic Update**, use **Manual Update**.
- 3 Select **Yes** and press the **OK** button to start updating. Select **No** and press the **OK** button to return to the previous menu without updating.
- 4 Performs Software Update. Please wait until it is completed.
- 5 When completing the software update, the TV is automatically powered off and on again.

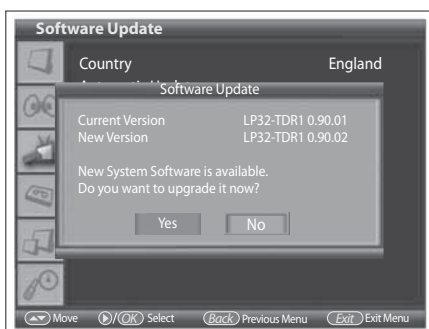

Manual Update

You can perform Manual Update only if you know MUX information of software update correctly.



- 1 Select **Manual Update** using the ▲/▼ button, and press the **OK** or ► button.
- 2 Select the channel number which provides update software using the ◀/▶ button. When you select the channel number, the frequency will be changed automatically.

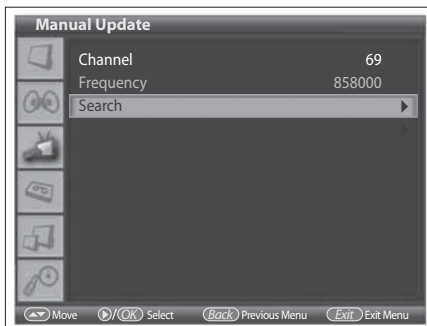

- 3 Select **Search** and press the **OK** or ► button to search software.
- 4 It is displayed whether or not New Software exist. If new software does not exist, press the **OK** button to return to the **Manual Update** menu.
- 5 Select **Yes** and press the **OK** button to start updating. Select **No** and press the **OK** button to return to the previous menu.
- 6 Performs Software Update. Please wait until it is completed.
- 7 When completing the software update, the TV is automatically powered off and on again.

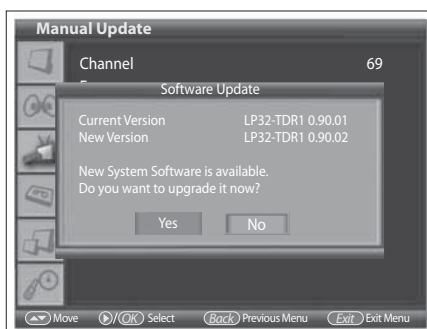





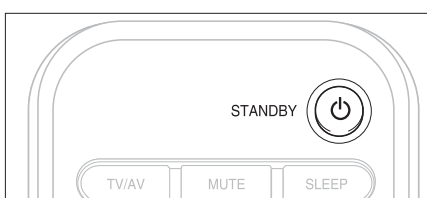

S/W Update from PC

You can connect your TV to the PC directly and update your software by transferring the new software from the PC. Follow these steps to download new software from PC to this TV.

- 1 Download new software file (HDF files) equivalent for this TV model from our website into your computer (<http://www.humaxdigital.com>).
- 2 Download and install download tool file from our website into your computer.
- 3 Connect your PC to this TV with **RS-232C** serial cable(not supplied).
- 4 Execute installed download tool, and then follow the instructions contained the download tool.
- 5 Reconnect the power cable of the TV and press the **STANDBY** button to make this TV operating.



Menu Structure

	Picture	<ul style="list-style-type: none"> - Mode - Brightness - Contrast - Sharpness - Colour - Noise Reduction - Fleshtone - Dynamic Contrast - Colour Temp. - Backlight Brightness
	Sound	<ul style="list-style-type: none"> - Effect - Balance - Auto Volume - TruSurround XT - Audio Priority ----- (Digital TV mode only)
	Channel	<ul style="list-style-type: none"> - Country - Auto Programme - Manual Programme - Edit Programmes - Software Update ----- (Digital TV mode only)
	PC (PC mode only)	<ul style="list-style-type: none"> - Auto Configure - Position - Clock - Phase
	Recording	<ul style="list-style-type: none"> - Schedule - Playlist - Recording Quality - HDD Control
	Screen	<ul style="list-style-type: none"> - PIP/PBP - Aspect Ratio
	System	<ul style="list-style-type: none"> - Language - Time Setting - Parental Controls ----- (Digital TV mode only) - CI ----- (Digital TV mode only) - Default Setting

Troubleshooting

Before contacting your local service dealer, please make sure you refer to the following guide. If the TV does not work normally after completing the following trouble shooting, please contact your local TV distributor or service centre.

- (1) No message is displayed on the front panel or the TV has no power.
 - Check the main power cable and make sure it is plugged into a suitable power outlet.
 - Check that the mains supply is switched on.
 - Check that the power switch is on at the side of the TV (where applicable)
- (2) No picture
 - Make sure that the TV is power on and in operation mode (press STANDBY button).
 - Make sure that the AV cable is firmly connected to the TV. You may need to remove the cable from both ends and reconnect.
 - Make sure that the antenna line is properly connected to the TV.
 - Make sure that the Antenna Setting in the menu is correct.
 - Check the brightness level of the TV.
 - Check if the channel is currently on air. Contact the broadcaster to ensure that the channel is running.
- (3) Poor picture & sound quality
 - Install the antenna in an obstacle-free place.
 - Make sure there is no mobile phone or microwave oven near the TV.
 - Use 75 coaxial cable when connecting TV and antenna.
 - In PIP/PBP/POP mode, if the 1080i video input signal is displayed on the sub screen through the Component or HDMI jack, the screen flicker may occur.
- (4) No or poor sound
 - Check that your AV cable is connected correctly.
 - Check the volume levels of your TV.
 - Check if the TV is on mute.
 - Check audio type or soundtrack option in the AV menu.
- (5) Remote Control does not operate.
 - To control the TV, the top end of the remote control should point directly towards the receiving part of the TV.
 - Remove and reinsert the batteries in the remote control.
 - Replace the batteries in the remote control for a new set.
- (6) Cannot make reservations.
 - Check that no previous reservations are conflicting with the new reservation.
 - Check that the TV is in operation mode or in standby mode at the time of the reservation. If the power switch or power outlet is off, the TV will not be able to switch on at the time of the reservation.
- (7) Cannot watch scrambled channel.
 - Check that you have the appropriate Smartcard or CAM. Reinsert the Smartcard or CAM and make sure it initializes correctly.
 - Check in the menu that the TV is detecting the Smartcard or CAM.
 - Check in the menu that you have a valid and working subscription to the channels you wish to view.
 - Ensure that the Smartcard or CAM is not damaged.

Error Message

Error message	Possible causes	What to do
No or bad signal	<ul style="list-style-type: none"> - The aerial is not pointing properly. - The AV device is not connected properly. 	<ul style="list-style-type: none"> - Adjust aerial. - Check the cable from the aerial. If you cannot resolve the problem you may need to have your aerial and installation tested by a professional. - Set the AV device correctly. - Check the cable from the AV device.
Scrambled or not available.	<ul style="list-style-type: none"> - The channel has signal, but no audio or video. - CI module is not plugged in. - CI module is not plugged in properly. - Wrong CI module is in use. 	<ul style="list-style-type: none"> - Confirm if the channel is currently on air. - The channel is not deleted by broadcasting company. The channel is for data broadcasting. Cannot watch the channel in usual way. - Insert CI module. - Reinsert CI module; ensure that it is inserted in the correct way. - Insert the appropriate CI module for the channel(s) you wish to view. - Contact your CI module retailer or channel broadcaster for a CI module replacement.
CI is not initialized.	<ul style="list-style-type: none"> - CI module is not plugged in. - CI module is not plugged in properly. - Wrong CI module is in use. 	<ul style="list-style-type: none"> - Insert CI module. - Reinsert CI module; ensure that it is inserted in the correct way. - Insert the appropriate CI module for the channel(s) you wish to view. - Contact your CI module retailer or channel broadcaster for a CI module replacement.
Hard disk is unmounted	<ul style="list-style-type: none"> - Hard disk drive is not recognized by reason that the hard disk drive connector is loose or the hard disk is not seated correctly. 	<ul style="list-style-type: none"> - Contact your local Customer Support for repair.
Hard Disk Drive Error	<ul style="list-style-type: none"> - Hard disk drive is damaged. 	<ul style="list-style-type: none"> - Contact your local Customer Support for repair.
Not enough free disk space.	<ul style="list-style-type: none"> - Free disk space is only 2GB. 	<ul style="list-style-type: none"> - Increase the free disk space by deleting unnecessary programmes in Playlist or moving them to an alternative storage.
Out of disk space.	<ul style="list-style-type: none"> - No free disk space. 	<ul style="list-style-type: none"> - Increase the free disk space by deleting unnecessary programmes in Playlist.
Schedule recording fail.	<ul style="list-style-type: none"> - The reserved channel is deleted. 	

Specification

Item		Specification	
LCD Panel	Type	Colour active matrix TFT-LCD	
	Display Area	32.0"	
	Max. Resolution	1366 x 768 pixels	
	Viewing Angle	R/L : 170 , U/D : 170 (CR ≥10)	
PC Monitor	Sync	Separate	
	Horizontal Frequency	31~61kHz	
	Vertical Frequency	56~75kHz	
	Max. Resolution	1280 x 1024 pixels@60Hz	
Input/Output	Video Input	Analog Tuner(1), Digital Tuner(2), SCART(2), RCA, RGB, S-Video, Component, HDMI	
	Audio Input	PC Audio, Component (R/L), RCA(R/L)	
	Audio Output	S/PDIF, Speaker, Headphone	
	Data Interface	RS-232C(for SW update)	
TV Signal		Analogue	Digital
	Area	EU	EU(MHEG)
	Antenna Input	IEC 169-2 Female	IEC 169-2 Female
	Tuning System	FS	OFDM DVB-T
	Colour System	PAL, B/G, D/K, I SECAM, B/G, D/K, L	B/G, I, D/K
	Sound System	AM / FM / Nicam	MPEG 1 Layer 1/2
	VHF Low	48.25 ~ 158.00 MHz	51 ~ 858 MHz
	VHF High	160.00 ~ 442.00 MHz	
	UHF	442.00 ~ 863.25 MHz	
	Teletext	Yes	Yes
Regulation	Safety	CE	
	EMI	CE	
Others	Power	180W (Max.)	
	Speaker Output	7W x 2EA	
	Plug & Play Level	DDC 1/2 B	
	Weight	NET 25.0 kg/Gross 31.0 kg	
	Power Supply	AC 100V ~240V, 50/60 Hz	
	HDD	160GB	

Service and Support

You can get information such as a troubleshooting guide, software upgrades and product support guide from the following web sites and call center (Hotline). Please try to contact to your local dealers first when facing a problem.

Web site and e-mail

Homepage

http://www.humaxdigital.com	English
http://www.humaxdigital.com/Deutsch/	Deutsch
http://www.humaxarabia.com	Arabic

HCSA (Humax Customer Service Area)

Software Download, Information and Technical Q&A

http://www.humaxdigital.com/hcsa/	English
http://www.humaxdigital.com/Deutsch/hcsa/	Deutsch

E-mail (Technical Q&A)

tech-info@humax-digital.co.uk	Europe & North Africa
techinfo@humax-digital.de	Germany
callcenterME@humaxdigital.com	Middle East
Webmaster@humaxdigital.com	Asia & Other area

Call Center

Humax Customer Helpline (UK)

Tel: 0870 247 8800

E-mail: uksupport@humax-digital.co.uk

Open: Local Time in UK (GMT+0), 08:30 – 18:00 (Monday -Friday)

Support Language: English

Humax Middle East Call Center (Dubai, UAE)

Tel: +971 (0)4 359 2323 (Open: 09:00 - 20:00 / close on Friday)

E-mail: callcenterME@humaxdigital.com

Open: Local Time in Dubai (GMT+4), 09:00 - 20:00 (Saturday - Thursday, close on Friday)

Support Language: English/Arabic

Humax Hotline (Germany)

Germany: 01805 778 900 (€ 0,12/Min)

Other Countries: + 49 1805 778 870 (€ 0,12/Min+ International Call Charge)

E-mail: support@humax-digital.de

Open: Local Time in Germany (GMT+1), 08:00 - 23:00 (Monday - Sunday)

Support Language: Deutsch/English

Humax BTCI Hotline (Premiere Model)

Germany: 01805-778900 (€ 0,12/Min)

Austria: 0900-900633 (€ 0,33/Min)

HUMAX Hotline (Italy)

Tel : 899 100080

E-mail : info@mediasat.com

Open : Local Time in Italy (GMT+1), 08:00~18:00 (Monday - Friday)

Support Language : Italian

HUMAX Hotline (Austria)

Tel : 0820 400675 (€ 0,12/min.)

HUMAX Hotline (Sweden)

Tel : +46 (0)550 85527

Open : 08:00 ~ 16:30 (Monday - Friday)

Support Language : Swedish/English

HUMAX Hotline (Finland)

Tel : 09 5618 6366

Open : 08:00 ~ 16:00 (Monday - Friday)

Support Language : Finnish/English

For hardware repair, please refer to website. (Homepage or HCSA)



<http://www.humaxdigital.com>

HUMAX
EASY DIGITAL

HLP32TDR1_200GB
P/N: 20010-1470